

**Professional Cleaning Equipment**



# **Technical Catalogue**



*English*











# Summary

---

<b>Company</b>	<b>5</b>	<b>Wringers</b>	<b>165</b>
<b>Mop Trolleys</b>	<b>13</b>	<b>Buckets and Plastic Components</b>	<b>171</b>
Mono	16	<b>Plastic Containers</b>	<b>183</b>
Duo	25	<b>Frames and Dust Flat Mops</b>	<b>189</b>
<b>Bag Holder Trolleys</b>	<b>41</b>	<b>Frames and Wet Flat Mops</b>	<b>199</b>
<b>Multifunctional Enclosed Plastic Trolleys</b>	<b>55</b>	<b>Kentucky Mops and Mop Holders</b>	<b>211</b>
DMX	58	<b>Handles and Telescopic Poles</b>	<b>219</b>
MX	76	<b>Window Cleaning Line and Floor Squeegees</b>	<b>227</b>
<b>Multifunctional Open Plastic Trolleys</b>	<b>91</b>	<b>Various Professional Products</b>	<b>239</b>
Ideabase	94	<b>Health Line</b>	<b>251</b>
Ideabase PL	103	DMX - Pre	<b>254</b>
Ideaplus	106	<b>Hotel Line</b>	<b>267</b>
<b>Multifunctional Chromium Plated Trolleys</b>	<b>115</b>	Classic	<b>270</b>
MINIMAX	118	Innovative	<b>280</b>
L	120	Elba	<b>294</b>
HO	124		
JOKER	128		
H	134		
EF	138		
<b>Multifunctional Trolleys with Rilsan Protection</b>	<b>143</b>		
EUROPE	146		
BIO - R	147		
<b>Multifunctional Stainless Steel Trolleys</b>	<b>153</b>		
BIOSTEEL	156		



# Professional Cleaning Systems

---

VDM products are designed and realized **according to our customers' specific needs.**

In this way, we are able to **create systems that are striving for maximum standard and cleaning protocols,** thus reducing the operational cost and meeting the needs of the most demanding operators.

Our trolleys are the **result of a special attention to design.** VDM's constant commitment is to **provide the Operators** with **greater functionality** and **ergonomics** combined with a **unique and distinctive aesthetic.**

**Our values are:**

**Quality**

---

**Products life**

---

**Ergonomics**

---

**Strength/Toughness**

---

**Innovation**

---

**Care for details**

---

**Technology**

---

**Design**

---

**Sustainability / Environmental liability**







# Our History

---

For over 40 years **we have been studying and designing with passion and care equipment and innovative systems to meet the needs of a constantly evolving market.**

We are present on the domestic and international market through distributors in **more than 64 countries in 5 continents.**

VDM has always been investing resources and efforts to find out **unique solutions at the service of the professional cleaning.**

**VDM was the first Italian company in the professional equipment sector to get a patent.** Among others, **the Elparoll roller wringer** has revolutionized the professional cleaning sector.







# Sustainability

# Environmental Responsibility

---

VDM has always been pursuing the quality respecting the environment, thanks to the continuous development of an Integrated Management System.

VDM was the first Italian company in the professional cleaning equipment sector to be certified:

UNI EN ISO 9001

---

UNI EN ISO 14001

These two certifications commit the company to continuously improve the structural-organizational aspects, leading to a service oriented towards the quality of the products and the preservation of the environment.

## DECLARATION OF CONFORMITY

---

All our products are complying with the current safety rules and are covered by a product civil liability policy







# Our Training Courses

---

Over the years, VDM has developed a **structure that is able to support the Distributor and the End User with highly «value-added» services:**

**Assistance**

---

**Education**

---

**Training**

---

**Marketing**

**VDM well known Training Centre can supply the customer with a «360° assistance», from the technical aspects, the suggestion of specific innovative systems, to the site start-up and following checks.**

Moreover, **we organize training courses for Operators, Construction Site Managers and Salesmen, both at our premises and on site.**





# Mop Trolleys

---

**Mono**

**16**

---

**Duo**

**25**

# Mop Trolleys



**Modular.** By using the ELPAROLL roller wringer (item no. 3501 VDM) it is possible to work adding a further 12 Lt bucket thus shifting from a single bucket to a double bucket unit and separating the dirty water from the clean one.



**Structure-integrated compartments.** The single bucket unit is equipped with a compartment where it is possible to store detergents, a 4 Lt bucket or various items.



**Accessories.** They can be equipped with a tool basket, 4 Lt bucket and plastic side container.





**Unique details.** The plastic handle is realized through the "gas molding" technique which makes it light-weighted since its inner part is empty. It is very robust and is equipped with an exclusive 5-position rotating system



**Stable and robust.** The unit is structured to withstand strong pressure during the wringing operation (the bottom of the wringer is placed on a three-point reinforced base). Moreover, thanks to the protruding barycenter of the castors and to the patented coupling system which firmly fix them to the bucket, the maximum stability of the trolley is ensured.

Plastic



Code	Description	Color
<b>SKY 1.15</b>	<b>Plastic trolley mono 1x15 lt</b>	
<b>SKY 1.15 S/P</b>	<b>Plastic trolley mono 1x15 lt without wringer</b>	
24040SKY/STD	1 Single frame with 4 castors Ø 80 mm (item no. 1038) for SKY	
24028	1 Support for 15 lt bucket for SKY	●
1205 R	1x15 lt bucket	●
24021SKY/STD	1 Wringer support without handle for SKY	
4100PA	1 Plastic wringer	●



Code	Description	Color
<b>SKY 1.25</b>	<b>Plastic trolley mono 1x25 lt</b>	
<b>SKY 1.25 S/P</b>	<b>Plastic trolley mono 1x25 lt without wringer</b>	
24040SKY/STD	1 Single frame with 4 castors Ø 80 mm (item no. 1038) for SKY	
1005 R	1x25 lt bucket	●
24021SKY/STD	1 Wringer support without handle for SKY	
4100PA	1 Plastic wringer	●

 55x46x88h cm



1 Pc/carton  
1 Pc/carton

8,2 Kg  
6,1 Kg

0,125 m<sup>3</sup>  
0,125m<sup>3</sup>

 55x46x88h cm



1 Pc/carton  
1 Pc/carton

8,2 Kg  
6,1 Kg

0,125 m<sup>3</sup>  
0,125 m<sup>3</sup>

Plastic



Code	Description	Color
<b>SKY 1.15 MP</b>	<b>Trolley mono 1x15 lt with plastic handle</b>	
<b>SKY 1.15 MPS/P</b>	<b>Trolley mono 1x15 lt with plastic handle without wringer</b>	
24040SKY/STD	1 Single frame with 4 castors Ø 80 mm (item no. 1038) for SKY	
24028	1 Support for 15 lt bucket for SKY	●
1205 R	1x15 lt bucket	●
24021SKY/MP	1 Wringer support with plastic reversible handle for SKY	
4100PA	1 Plastic wringer	●

Code	Description	Color
<b>SKY 1.25 MP</b>	<b>Trolley mono 1x25 lt with plastic handle</b>	
<b>SKY 1.25 MPS/P</b>	<b>Trolley mono 1x25 lt with plastic handle without wringer</b>	
24040SKY/STD	1 Single frame with 4 castors Ø 80 mm (item no. 1038) for SKY	
1005 R	1x25 lt bucket	●
24021SKY/MP	1 Wringer support with plastic reversible handle for SKY	
4100PA	1 Plastic wringer	●

55x46x88h cm	<table border="1"> <tr> <td></td> <td>1 Pc/carton</td> <td>8,7 Kg</td> <td>0,125 m<sup>3</sup></td> </tr> <tr> <td></td> <td>1 Pc/carton</td> <td>6,6 Kg</td> <td>0,125 m<sup>3</sup></td> </tr> </table>		1 Pc/carton	8,7 Kg	0,125 m <sup>3</sup>		1 Pc/carton	6,6 Kg	0,125 m <sup>3</sup>
	1 Pc/carton	8,7 Kg	0,125 m <sup>3</sup>						
	1 Pc/carton	6,6 Kg	0,125 m <sup>3</sup>						

55x46x88h cm	<table border="1"> <tr> <td></td> <td>1 Pc/carton</td> <td>8,7 Kg</td> <td>0,125 m<sup>3</sup></td> </tr> <tr> <td></td> <td>1 Pc/carton</td> <td>6,6 Kg</td> <td>0,125 m<sup>3</sup></td> </tr> </table>		1 Pc/carton	8,7 Kg	0,125 m <sup>3</sup>		1 Pc/carton	6,6 Kg	0,125 m <sup>3</sup>
	1 Pc/carton	8,7 Kg	0,125 m <sup>3</sup>						
	1 Pc/carton	6,6 Kg	0,125 m <sup>3</sup>						









Plastic



Code	Description	Color
ALEX 1A+P	Mono plastic mopping bucket 20 lt	●
ALEX 1G+P	Mono plastic mopping bucket 20 lt	●
ALEX 1R+P	Mono plastic mopping bucket 20 lt	●
ALEX 1V+P	Mono plastic mopping bucket 20 lt	●
ALEX 1A S/P	Mono plastic mopping bucket 20 lt without wringer	●
ALEX 1G S/P	Mono plastic mopping bucket 20 lt without wringer	●
ALEX 1R S/P	Mono plastic mopping bucket 20 lt without wringer	●
ALEX 1V S/P	Mono plastic mopping bucket 20 lt without wringer	●
1006/A	1x20 lt bucket for ALEX	●
GR1009/SET	1 Set of supports with castors for ALEX (4 pcs)	●
4100PA	1 Plastic wringer	●

Code	Description	Color
ALEX 2A+P	Duo plastic mopping bucket 20 lt (10+10)	●
ALEX 2G+P	Duo plastic mopping bucket 20 lt (10+10)	●
ALEX 2R+P	Duo plastic mopping bucket 20 lt (10+10)	●
ALEX 2V+P	Duo plastic mopping bucket 20 lt (10+10)	●
ALEX 2A S/P	Duo plastic mopping bucket 20 lt (10+10) without wringer	●
ALEX 2G S/P	Duo plastic mopping bucket 20 lt (10+10) without wringer	●
ALEX 2R S/P	Duo plastic mopping bucket 20 lt (10+10) without wringer	●
ALEX 2V S/P	Duo plastic mopping bucket 20 lt (10+10) without wringer	●
1006/A	1x20 lt bucket for ALEX	●
2235 A	1x12 lt bucket	●
GR1009/SET	1 Set of supports with castors for ALEX (4 pcs)	●
4100PA	1 Plastic wringer	●

 52x40x82h cm	 1 Pc/carton	7 Kg	0,100 m <sup>3</sup>
	 3 Pcs/carton	12 Kg	0,100 m <sup>3</sup>

 52x40x82h cm	 1 Pc/carton	7,3 Kg	0,100 m <sup>3</sup>
	 2 Pcs/carton	9 Kg	0,100 m <sup>3</sup>



## Plastic



Code	Description	Color
------	-------------	-------

<b>ALEX COMBI</b>	<b>Plastic mopping bucket "2 rollers" 20 lt (10+10)</b> 1 Ergonomic plastic mopping unit 20 lt (10+10) equipped with 1x12 lt bucket, 2 elastic rollers (foot operated), INOX (AISI 304) mechanism, bottom filter, 4 castors Ø 80 mm	●
-------------------	--	---

Code	Description	Color
------	-------------	-------

<b>MAC 50A+P</b>	<b>Mono plastic mopping bucket 20 lt</b>	●
<b>MAC 50G+P</b>	<b>Mono plastic mopping bucket 20 lt</b>	●
<b>MAC 50R+P</b>	<b>Mono plastic mopping bucket 20 lt</b>	●
<b>MAC 50V+P</b>	<b>Mono plastic mopping bucket 20 lt</b>	●
<b>MAC 50A S/P</b>	<b>Mono plastic mopping bucket 20 lt without wringer</b>	●
<b>MAC 50G S/P</b>	<b>Mono plastic mopping bucket 20 lt without wringer</b>	●
<b>MAC 50R S/P</b>	<b>Mono plastic mopping bucket 20 lt without wringer</b>	●
<b>MAC 50V S/P</b>	<b>Mono plastic mopping bucket 20 lt without wringer</b>	●
1070 A	1x20 lt bucket for MAC	●
1075	4 Supports with castors Ø 50 mm for MAC	●
4100PA	1 Plastic wringer	●

 52x40x55h cm |  1 Pc/carton 7,7 Kg 0,125 m<sup>3</sup>

 40x35x75h cm |  1 Pc/cartons 5 Kg 0,065 m<sup>3</sup>  
 3 Pcs/cartons 7,7 Kg 0,100 m<sup>3</sup>

Plastic



Code	Description	Color
MAC 80A+P	Mono plastic mopping bucket 20 lt	●
MAC 80G+P	Mono plastic mopping bucket 20 lt	●
MAC 80R+P	Mono plastic mopping bucket 20 lt	●
MAC 80V+P	Mono plastic mopping bucket 20 lt	●
MAC 80A S/P	Mono plastic mopping bucket 20 lt without wringer	●
MAC 80G S/P	Mono plastic mopping bucket 20 lt without wringer	●
MAC 80R S/P	Mono plastic mopping bucket 20 lt without wringer	●
MAC 80V S/P	Mono plastic mopping bucket 20 lt without wringer	●
1070 A	1x20 lt bucket for MAC	●
1076	4 Supports with castors Ø 80 mm for MAC	●
4100PA	1 Plastic wringer	●

Code	Description	Color
4600	MAC ROLL plastic mopping bucket 20 lt	●
4600 S/P	MAC ROLL plastic mopping bucket 20 lt without wringer	●
1070 A	1x20 lt bucket for MAC	
1075	4 Supports with castors Ø 50 mm for MAC	
4601	1 Plastic roller wringer - for semi professional use	

Semi Professional

40x35x80h cm	1 Pc/carton	5,3 Kg	0,065 m <sup>3</sup>
	3 Pcs /carton	8,8 Kg	0,100 m <sup>3</sup>

45x32x60h cm	1 Pc/carton	4,8 Kg	0,065 m <sup>3</sup>
	3 Pcs /carton	2,8 Kg	0,065 m <sup>3</sup>

## Plastic



Code	Description	Color
4630	MAC ROLL DUO plastic mopping bucket 20 lt	●
4630 S/P	MAC ROLL DUO plastic mopping bucket 20 lt without wringer	●
1070 A	1x20 lt bucket for MAC	●
4635	1x8 lt bucket	●
1075	4 Supports with castors Ø 50 mm for MAC	
4601	1 Plastic roller wringer - for semi professional use	

Semi Professional

Chromium  
plated steel

Code	Description	Color
CP 2600	Foot operated chromed trolley 12 lt with 2 rollers	
GRCP2600 2235 R	1 Frame with elastic rollers (foot operated) for CP 1x12 lt bucket	●

 45x32x60h cm

 1 Pc/carton  
2 Pcs/carton

 5,4 Kg  
3,4 Kg

 0,070 m<sup>3</sup>  
0,030 m<sup>3</sup>
 40x39x40h cm

2 Pcs/carton

11 Kg

0,125 m<sup>3</sup>

Chromium plated steel



Code	Description	Color
SA 1.15.80+P	Chromed trolley mono 1x15 lt	
SA 1.15.80 S/P	Chromed trolley mono 1x15 lt without wringer	
GR1390	1 SA 1x15/25 frame with welded frame equipped with 4 castors Ø 80 mm (item no. 1431) and bumpers	
1205 R	1x15 lt bucket	●
4100PR	1 Plastic wringer	●



Code	Description	Color
SA 1.25.80+P	Chromed trolley mono 1x25 lt	
SA 1.25.80 S/P	Chromed trolley mono 1x25 lt without wringer	
GR1390	1 SA 1x15/25 frame with welded frame equipped with 4 castors Ø 80 mm (item no. 1431) and bumpers	
1005 R	1x25 lt bucket	●
4100PR	1 Plastic wringer	●

 48x38x90h cm



2 Pcs/carton  
2 Pcs/carton

12,8 Kg  
10,5 Kg

0,225 m<sup>3</sup>  
0,225 m<sup>3</sup>

 48x38x90h cm



2 Pcs/carton  
2 Pcs/carton

13 Kg  
10,5 Kg

0,225 m<sup>3</sup>  
0,225 m<sup>3</sup>

Chromium  
plated steel

Code	Description	Color
------	-------------	-------

SE 1.25.80+P	Chromed trolley mono 1x25 lt	
--------------	------------------------------	--

SE 1.25.80 S/P	Chromed trolley mono 1x25 lt without wringer	
----------------	--	--

GR1905	1 SE 1x25 base with 4 castors Ø 80 mm (item no. 1030) and bumpers	
1005 R	1x25 lt bucket	●
1981	1 Vertical wringer support with anti - reversal system 1x25 lt	●
4100PR	1 Plastic wringer	
KITSE	1 Assembling kit with plates	

Code	Description	Color
------	-------------	-------

SJ 1.15.80+P	Chromed trolley mono 1x15 lt	
--------------	------------------------------	--

SJ 1.15.80 S/P	Chromed trolley mono 1x15 lt without wringer	
----------------	--	--

GR1201	1 SJ 15/25 frame with reinforced welded vertical frame, wringer support with anti-reversal system and equipped with 4 castors Ø 80 mm (item no. 1030) and bumpers	
1205 R	1x15 lt bucket	●
4100PR	1 Plastic wringer	●

 48x38x90h cm	<table border="1"> <tbody> <tr> <td>3 Pcs/carton</td> <td>26 Kg</td> <td>0,185 m<sup>3</sup></td> </tr> <tr> <td>5 Pcs/carton</td> <td>29 Kg</td> <td>0,185 m<sup>3</sup></td> </tr> </tbody> </table>	3 Pcs/carton	26 Kg	0,185 m <sup>3</sup>	5 Pcs/carton	29 Kg	0,185 m <sup>3</sup>
3 Pcs/carton	26 Kg	0,185 m <sup>3</sup>					
5 Pcs/carton	29 Kg	0,185 m <sup>3</sup>					

 48x38x96h cm	<table border="1"> <tbody> <tr> <td>2 Pcs/carton</td> <td>16,5 Kg</td> <td>0,225 m<sup>3</sup></td> </tr> <tr> <td>2 Pcs/carton</td> <td>12 Kg</td> <td>0,225 m<sup>3</sup></td> </tr> </tbody> </table>	2 Pcs/carton	16,5 Kg	0,225 m <sup>3</sup>	2 Pcs/carton	12 Kg	0,225 m <sup>3</sup>
2 Pcs/carton	16,5 Kg	0,225 m <sup>3</sup>					
2 Pcs/carton	12 Kg	0,225 m <sup>3</sup>					

**Optional** (shown in the picture)

1510	Basket for SE/SJ
GR1203	Fixed handle with screws for EC/SJ/LZ

Chromium plated steel



Code	Description	Color
SJ 1.25.80+P	Chromed trolley mono 1x25 lt	
SJ 1.25.80 S/P	Chromed trolley mono 1x25 lt without wringer	
GR1201	1 SJ 15/25 frame with reinforced welded vertical frame, wringer support with anti-reversal system and equipped with 4 castors Ø 80 mm (item no. 1030) and bumpers	
1005 R	1x25 lt bucket	●
4100PR	1 Plastic wringer	●



Code	Description	Color
MINIMAX 1	Folding chromed trolley mono 1x25 lt	
MINIMAX 1 S/P	Folding chromed trolley mono 1x25 lt without wringer	
GRMINIMAX1	1 Folding frame with 4 castors Ø 80 mm (item no. 1430) and bumpers for MINIMAX 1	
1005 R	1x25 lt bucket	●
2023 A	1 Tray for MINIMAX	●
4100PR	1 Plastic wringer	●

 48x38x96h cm



2 Pcs/carton 17 Kg 0,225 m<sup>3</sup>  
2 Pcs/carton 12 Kg 0,225 m<sup>3</sup>

 55x45x97h cm



2 Pcs/carton 22,3 Kg 0,290 m<sup>3</sup>  
2 Pcs/carton 17,8 Kg 0,290 m<sup>3</sup>

**Optional** (shown in the picture)

1510 Basket for SE/SJ  
GR1203 Fixed handle with screws for EC/SJ/LZ

Plastic



Code	Description	Color
------	-------------	-------

**SKY COMPACT** Plastic trolley duo (1x25 lt + 1x12 lt)

**SKY COMPACT S/P** Plastic trolley duo(1x25 lt + 1x12 lt) without wringer

24040SKY/STD	1 Single frame with 4 castors Ø 80 mm (item no. 1038) for SKY	
2235 A	1x12 lt bucket	●
1005 R	1x25 lt bucket	●
24021SKY/STD	1 Wringer support without handle for SKY	
4100PA	1 Plastic wringer	●

Code	Description	Color
------	-------------	-------

**SKY COMPACT MP** Duo trolley (1x25 lt + 1x12 lt) with plastic handle

**SKY COMPACT MP S/P** Duo trolley (1x25 lt + 1x12 lt) with plastic handle without wringer

24040SKY/STD	1 Single frame with 4 castors Ø 80 mm (item no. 1038) for SKY	
2235 A	1x12 lt bucket	●
1005 R	1x25 lt bucket	●
24021SKY/MP	1 Wringer support with plastic reversible handle for SKY	
4100PA	1 Plastic wringer	●

61x46x88h cm	1 Pc/carton	9 Kg	0,125 m <sup>3</sup>
	1 Pc/carton	6,9 Kg	0,125 m <sup>3</sup>

61x46x88h cm	1 Pc/carton	9,7 Kg	0,125 m <sup>3</sup>
	1 Pc/carton	7,6 Kg	0,125 m <sup>3</sup>



Code	Description	Color
<b>SKY 2.15</b>	<b>Trolley duo 2x15 lt with reversible handle with rilsan protection</b>	
<b>SKY 2.15 S/P</b>	<b>Trolley duo 2x15 lt with reversible handle with rilsan protection without wringer</b>	
24020SKY/STD	1 Double frame equipped with 4 castors Ø 80 mm (item no. 1038) for SKY	●
24028	2 Supports for 15 lt bucket for SKY	●
20051	1 Reversible handle for SKY	●
1205 A	1x15 lt bucket	●
1205 R	1x15 lt bucket	●
24021SKY/STD	1 Wringer support without handle for SKY	●
4100PA	1 Plastic wringer	●



Code	Description	Color
<b>SKY 2.25</b>	<b>Trolley duo 2x25 lt with reversible handle with rilsan protection</b>	
<b>SKY 2.25 S/P</b>	<b>Trolley duo 2x25 lt with reversible handle with rilsan protection without wringer</b>	
24020SKY/STD	1 Double frame equipped with 4 castors Ø 80 mm (item no. 1038) for SKY	●
20051	1 Reversible handle for SKY	●
1005 A	1x25 lt bucket	●
1005 R	1x25 lt bucket	●
24021SKY/STD	1 Wringer support without handle for SKY	●
4100PA	1 Plastic wringer	●

 70x46x88h cm



1 Pc/carton  
1 Pc/carton

10,5 Kg  
8,4 Kg

0,185 m<sup>3</sup>  
0,185 m<sup>3</sup>

 70x46x88h cm



1 Pc/carton  
1 Pc/carton

10,5 Kg  
8,4 Kg

0,185 m<sup>3</sup>  
0,185 m<sup>3</sup>



Plastic



Code	Description	Color
<b>SKY 2.15 MP</b>	<b>Trolley duo 2x15 lt with plastic handle</b>	
<b>SKY 2.15 MPS/P</b>	<b>Trolley duo 2x15 lt with plastic handle without wringer</b>	
24020SKY/STD	1 Double frame equipped with 4 castors Ø 80 mm (item no. 1038) for SKY	●
24028	2 Supports for 15 lt bucket for SKY	●
1205 A	1x15 lt bucket	●
1205 R	1x15 lt bucket	●
24021SKY/MP	1 Wringer support with plastic reversible handle for SKY	●
4100PA	1 Plastic wringer	●

Code	Description	Color
<b>SKY 2.25 MP</b>	<b>Trolley duo 2x25 lt with plastic handle</b>	
<b>SKY 2.25 MPS/P</b>	<b>Trolley duo 2x25 lt with plastic handle without wringer</b>	
24020SKY/STD	1 Double frame equipped with 4 castors Ø 80 mm (item no. 1038) for SKY	●
1005 A	1x25 lt bucket	●
1005 R	1x25 lt bucket	●
24021SKY/MP	1 Wringer support with plastic reversible handle for SKY	●
4100PA	1 Plastic wringer	●

70x46x88h cm	<table border="0"> <tr> <td></td> <td>1 Pc/carton</td> <td>10 Kg</td> <td>0,185 m<sup>3</sup></td> </tr> <tr> <td></td> <td>1 Pc/carton</td> <td>8 Kg</td> <td>0,185 m<sup>3</sup></td> </tr> </table>		1 Pc/carton	10 Kg	0,185 m <sup>3</sup>		1 Pc/carton	8 Kg	0,185 m <sup>3</sup>
	1 Pc/carton	10 Kg	0,185 m <sup>3</sup>						
	1 Pc/carton	8 Kg	0,185 m <sup>3</sup>						

70x46x88h cm	<table border="0"> <tr> <td></td> <td>1 Pc/carton</td> <td>10 Kg</td> <td>0,185 m<sup>3</sup></td> </tr> <tr> <td></td> <td>1 Pc/carton</td> <td>8 Kg</td> <td>0,185 m<sup>3</sup></td> </tr> </table>		1 Pc/carton	10 Kg	0,185 m <sup>3</sup>		1 Pc/carton	8 Kg	0,185 m <sup>3</sup>
	1 Pc/carton	10 Kg	0,185 m <sup>3</sup>						
	1 Pc/carton	8 Kg	0,185 m <sup>3</sup>						

Chromium plated steel



Code	Description	Color
SA 2.15.80+P	Chromed trolley duo 2x15 lt with reversible handle	
SA 2.15.80 S/P	Chromed trolley duo 2x15 lt with reversible handle without wringer	
GR1393	1 Frame with 4 castors Ø 80 mm (item no. 1431) and bumpers for SA 2x15	
1392	1 Reversible handle for SA	●
1205 A	1x15 lt bucket	●
1205 R	1x15 lt bucket	●
4100PR	1 Plastic wringer	●

Code	Description	Color
SA 2.25.80+P	Chromed trolley duo 2x25 lt with reversible handle	
SA 2.25.80 S/P	Chromed trolley duo 2x25 lt with reversible handle without wringer	
GR1391	1 SA 2x25 frame with 4 castors Ø 80 mm (item no. 1431) and bumpers	
1392	1 Reversible handle for SA	●
1005 A	1x25 lt bucket	●
1005 R	1x25 lt bucket	●
4100PR	1 Plastic wringer	●

62x45x80h cm	2 Pcs/carton	20,4 Kg	0,290 m <sup>3</sup>
	2 Pcs/carton	16 Kg	0,290 m <sup>3</sup>

62x45x80h cm	2 Pcs/carton	20,8 Kg	0,290 m <sup>3</sup>
	2 Pcs/carton	16 Kg	0,290 m <sup>3</sup>

Chromium  
plated steel



Code	Description	Color
EC 2.25.80+P	Chromed trolley duo 2x25 lt with fix handle	
EC 2.25.80 S/P	Chromed trolley duo 2x25 lt with fix handle without wringer	
GR1210	1 Frame with 4 castors Ø 80 mm (item no. 1030/ZE) and bumpers for EC 2x25	
GR1203	1 Fixed handle with screws for EC/SJ/LZ	
1005 A	1x25 lt bucket	●
1005 R	1x25 lt bucket	●
4100PR	1 Plastic wringer	●

Code	Description	Color
E 2.15.80+P	Chromed trolley duo 2x15 lt with reversible handle	
E 2.15.80 S/P	Chromed trolley duo 2x15 lt with reversible handle without wringer	
GR1220	1 Frame with 4 castors Ø 80 mm (item no. 1030) and bumpers for E/EMF 2x15	
1025	1 Reversible handle for E	
1205 A	1x15 lt bucket	●
1205 R	1x15 lt bucket	●
4100PR	1 Plastic wringer	●

While stock last

65x42x81h cm	<table border="0"> <tr> <td></td> <td>2 Pcs/carton</td> <td>20,4 Kg</td> <td>0,290 m<sup>3</sup></td> </tr> <tr> <td></td> <td>2 Pcs/carton</td> <td>16 Kg</td> <td>0,290 m<sup>3</sup></td> </tr> </table>		2 Pcs/carton	20,4 Kg	0,290 m <sup>3</sup>		2 Pcs/carton	16 Kg	0,290 m <sup>3</sup>
	2 Pcs/carton	20,4 Kg	0,290 m <sup>3</sup>						
	2 Pcs/carton	16 Kg	0,290 m <sup>3</sup>						

65x42x88h cm	<table border="0"> <tr> <td></td> <td>2 Pcs/carton</td> <td>23,7 Kg</td> <td>0,290 m<sup>3</sup></td> </tr> <tr> <td></td> <td>2 Pcs/carton</td> <td>19 Kg</td> <td>0,290 m<sup>3</sup></td> </tr> </table>		2 Pcs/carton	23,7 Kg	0,290 m <sup>3</sup>		2 Pcs/carton	19 Kg	0,290 m <sup>3</sup>
	2 Pcs/carton	23,7 Kg	0,290 m <sup>3</sup>						
	2 Pcs/carton	19 Kg	0,290 m <sup>3</sup>						

Chromium plated steel



Code	Description	Color
E 2.25.80+P	Chromed trolley duo 2x25 lt with reversible handle	
E 2.25.80 S/P	Chromed trolley duo 2x25 lt with reversible handle without wringer	
GR1015	1 Frame with 4 castors Ø 80 mm (item no. 1030) and bumpers for E/EMF 2x25	
1025	1 Reversible handle for E	●
1005 A	1x25 lt bucket	●
1005 R	1x25 lt bucket	●
4100PR	1 Plastic wringer	●

While stock last



Code	Description	Color
EMF 2.25.80+P	Chromed trolley duo 2x25 lt with fix handle	
EMF 2.25.80 S/P	Chromed trolley duo 2x25 lt with fix handle without wringer	
GR1015	1 Frame with 4 castors Ø 80 mm (item no. 1030) and bumpers for E/EMF 2x25	
GR1090	1 Fixed handle for EMF	
1095	1 Basket for EMF	
1005 A	1x25 lt bucket	●
1005 R	1x25 lt bucket	●
4100PR	1 Plastic wringer	●
KITEMF	1 Assembling kit for EMF	

While stock last

65x42x88h cm	2 Pcs/carton	24 Kg	0,290 m <sup>3</sup>
	2 Pcs/carton	19 Kg	0,290 m <sup>3</sup>

65x42x90h cm	2 Pcs/carton	24,4 Kg	0,290 m <sup>3</sup>
	2 Pcs/carton	19 Kg	0,290 m <sup>3</sup>

Chromium  
plated steel



Code	Description	Color
P 2.15.80+P	Folding chromed trolley duo 2x15 lt	
P 2.15.80 S/P	Folding chromed trolley duo 2x15 lt without wringer	
GRP15	1 Folding frame with integrated fixed handle equipped with 4 castors Ø 80 mm (item no. 1430) and bumpers for P 15	
1205 A	1x15 lt bucket	●
1205 R	1x15 lt bucket	●
4100PR	1 Plastic wringer	●

Code	Description	Color
P 2.25.80+P	Folding chromed trolley duo 2x25 lt	
P 2.25.80 S/P	Folding chromed trolley duo 2x25 lt without wringer	
GRP25	1 Folding frame with integrated fixed handle equipped with 4 castors Ø 80 mm (item no. 1430) and bumpers for P 25	
1005 A	1x25 lt lt bucket	●
1005 R	1x25 lt lt bucket	●
4100PR	Plastic wringer	●

Folding

Folding

 84x51x82h cm |  2 Pcs/carton 21 Kg 0,290 m<sup>3</sup>  
2 Pcs/carton 19 Kg 0,290 m<sup>3</sup>

 84x51x82h cm |  2 Pcs/carton 24 Kg 0,290 m<sup>3</sup>  
2 Pcs/carton 19 Kg 0,290 m<sup>3</sup>

Optional (shown in the picture)

1350 Basket for P

Optional (shown in the picture)

1350 Basket for P

Stainless steel



Code	Description	Color
<b>BIOSTEELP15+P</b>	<b>Folding stainless steel trolley duo 2x15 lt</b>	
<b>BIOSTEELP15S/P</b>	<b>Folding stainless steel trolley duo 2x15 lt without wringer</b>	
GRBIOSTEELP15	1 Stainless steel folding frame with integrated fixed handle equipped with 4 castors Ø 80 mm (item no. 1430) and bumpers for BIOSTEEL P 15	
1205 A	1x15 lt bucket	●
1205 R	1x15 lt bucket	●
4100PR	1 Plastic wringer	●

Code	Description	Color
<b>BIOSTEELP25+P</b>	<b>Folding stainless steel trolley duo 2x25 lt</b>	
<b>BIOSTEELP25S/P</b>	<b>Folding stainless steel trolley duo 2x25 lt without wringer</b>	
GRBIOSTEELP25	1 Stainless steel folding frame integrated fixed handle equipped with 4 castors Ø 80 mm (item no. 1430) and bumpers for BIOSTEEL P 25	
1005 A	1x25 lt bucket	●
1005 R	1x25 lt bucket	●
4100PR	1 Plastic wringer	●

Folding

Folding

84x51x82h cm	2 Pcs/carton	22,5 Kg	0,290 m <sup>3</sup>
	2 Pcs/carton	17,7 Kg	0,290 m <sup>3</sup>

84x51x82h cm	2 Pcs/carton	22,5 Kg	0,290 m <sup>3</sup>
	2 Pcs/carton	17,7 Kg	0,290 m <sup>3</sup>

Chromium  
plated steel

Code	Description	Color
------	-------------	-------

L 2.15.80+P	Chromed duo mop trolley 2x15 lt	
-------------	---------------------------------	--

L 2.15.80 S/P	Chromed duo mop trolley 2x15 lt without wringer	
---------------	---	--

GR1412	1 LUSO Frame 2x15 with rotating wringer support equipped with 4 castors Ø 80 mm (item no. 1430) and bumpers	
GR1425	1 Reversible handle for DELUXE	
1205 A	1x15 lt bucket	●
1205 R	1x15 lt bucket	●
4100PR	1 Plastic wringer	●

While stock last

Rotating wringer support

Code	Description	Color
------	-------------	-------

L 2.25.80+P	Chromed duo mop trolley 2x25 lt	
-------------	---------------------------------	--

L 2.25.80 S/P	Chromed duo mop trolley 2x25 lt without wringer	
---------------	---	--

GR1415	1 LUSO Frame 2x25 with rotating wringer support equipped with 4 castors Ø 80 mm (item no. 1430) and bumpers	
GR1425	1 Reversible handle for DELUXE	
1005 A	1x25 lt bucket	●
1005 R	1x25 lt bucket	●
4100PR	1 Plastic wringer	●

While stock last

Rotating wringer support

66x43x88h cm	1 Pc/carton	13,5 Kg	0,185 m <sup>3</sup>
	1 Pc/carton	11 Kg	0,185 m <sup>3</sup>







66x43x88h cm	1 Pc/carton	13,5 Kg	0,185 m <sup>3</sup>
	1 Pc/carton	11 Kg	0,185 m <sup>3</sup>

Plastic









Code	Description	Color
<b>IDEA 15</b>	<b>Plastic trolley 2x15 lt</b>	
<b>IDEA 15 S/P</b>	<b>Plastic trolley 2x15 lt without wringer</b>	
20015IDEA/STD	1 Duomop frame equipped with 4 castors Ø 80 mm (item no. 1038) for IDEA	
20051	1 Reversible handle for SKY	
20055	4 Supports for 15 Lt bucket for IDEA	
1205 B	1x15 Lt bucket	●
1205 R	1x15 Lt bucket	●
4100PR	1 Plastic wringer	●

Code	Description	Color
<b>IDEA 25</b>	<b>Plastic trolley 2x25 lt</b>	
<b>IDEA 25 S/P</b>	<b>Plastic trolley 2x25 lt without wringer</b>	
20015IDEA/STD	1 Duomop frame equipped with 4 castors Ø 80 mm (item no. 1038) for IDEA	
20051	1 Reversible handle for SKY	
1005 B	1x25 Lt bucket	●
1005 R	1x25 Lt bucket	●
4100PR	1 Plastic wringer	●

 70x45x88h cm	<table border="1"> <tr> <td></td> <td>1 Pc/carton</td> <td>11,4 Kg</td> <td>0,185 m<sup>3</sup></td> </tr> <tr> <td></td> <td>1 Pc/carton</td> <td>9,1 Kg</td> <td>0,185 m<sup>3</sup></td> </tr> </table>		1 Pc/carton	11,4 Kg	0,185 m <sup>3</sup>		1 Pc/carton	9,1 Kg	0,185 m <sup>3</sup>
	1 Pc/carton	11,4 Kg	0,185 m <sup>3</sup>						
	1 Pc/carton	9,1 Kg	0,185 m <sup>3</sup>						

**Optional** (shown in the picture)  
20060 Side basket SKY

 70x45x88h cm	<table border="1"> <tr> <td></td> <td>1 Pc/carton</td> <td>11,4 Kg</td> <td>0,185 m<sup>3</sup></td> </tr> <tr> <td></td> <td>1 Pc/carton</td> <td>9,1 Kg</td> <td>0,185 m<sup>3</sup></td> </tr> </table>		1 Pc/carton	11,4 Kg	0,185 m <sup>3</sup>		1 Pc/carton	9,1 Kg	0,185 m <sup>3</sup>
	1 Pc/carton	11,4 Kg	0,185 m <sup>3</sup>						
	1 Pc/carton	9,1 Kg	0,185 m <sup>3</sup>						

**Optional** (shown in the picture)  
20060 Side basket SKY



Plastic/Rilsan



Chromium  
plated steel



Code	Description	Color
------	-------------	-------

**TROLO400SP Multiservice trolley in plastic/rilsan**

- 20078 1 TROLO structure
- 20015IDEA/TROLO 1 Frame with 4 castors Ø 125 mm (item no. 21012) for IDEA
- 20051 1 Reversible handle for SKY
- 20060 2 Side baskets SKY
- 8311/R 2 Small handle holder
- 7030 B 1x22 lt rect. bucket
- 1005 B 1x25 lt bucket
- 1005 R 1x25 lt bucket
- 7032 1 Folding stainless steel grid (for 22 lt rect. bucket)



Code	Description	Color
------	-------------	-------

**MINITROL 15 Multifunctional folding chromed trolley**









**MINITROL 15S/P Multifunctional folding chromed trolley without wringer**

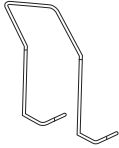
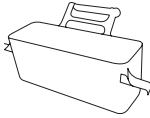
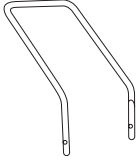



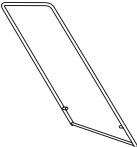
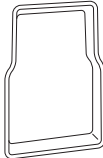
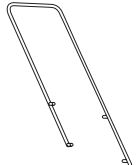
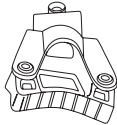
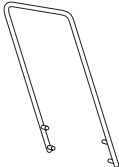
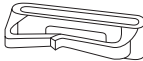
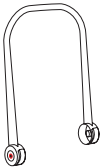
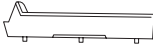

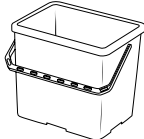

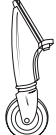
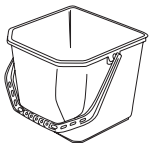

- GRMINITROL 1 Folding frame equipped with 2 castors Ø 80 mm (item no. 1430) and 2 castors with brake Ø 80 mm (item no. 1430/FR) and bumpers
- 1 Bucket holder for MINITROL
- 1452 1x6 lt bucket
- 2250 A 1x6 lt bucket
- 2250 GR 1x6 lt bucket
- COMFORT A S/S 1x15 lt COMFORT bucket without wringing sieve
- MICRO4550 1 MICROROLL 4550 wringer
- 2022 A 1 Tray narrow
- 2255 1 Rubber handle holder with coupling system Ø 22 mm

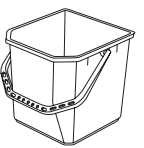

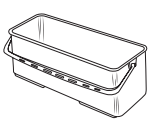
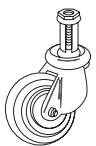

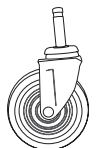
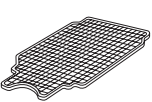

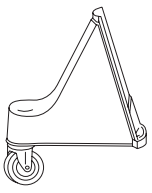
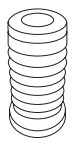
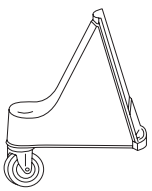
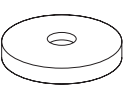
70x54x103h cm	1 Pc/carton	15,40 Kg	0,33 m <sup>3</sup>
---------------	-------------	----------	---------------------

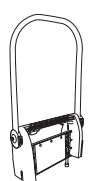
42x36x105h cm	1 Pc/carton	9 Kg	0,150 m <sup>3</sup>
	1 Pc/carton	7,5 Kg	0,150 m <sup>3</sup>

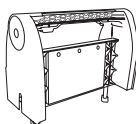
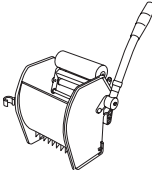
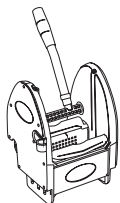
	Code	Description	Color		Code	Description	Color
	GR1090	Fixed handle for EMF			24038	Plastic basket for SKY	●
	GR1203	Fixed handle with screws for EC/SJ/LZ			1510	Basket for SE/SJ	
	GR1425	Reversible handle for DELUXE			20060	Side basket SKY	●
	1025	Reversible handle for E			2023 A	Tray for MINIMAX	●
	1392	Reversible handle for SA			2255	Rubber handle holder with coupling system Ø 22 mm	
	20051	Reversible handle for SKY			8311/R	Small handle holder	●
	GR24030	Plastic handle SKY			24028	Support for 15 lt bucket for SKY	●
	1095	Basket for EMF			2250 A 2250 GR	6 lt bucket	● ●
	1350	Basket for P			4635	8 lt bucket	●

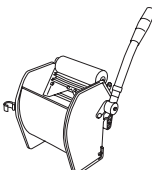
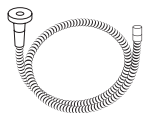
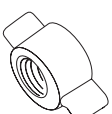
Code	Description	Color	Code	Description	Color
 2235 A 2235 GR 2235 R	12 Lt bucket	● ● ●	 1076	Support with castor Ø 80 mm for MAC	
 1205 A 1205 B 1205 R	15 Lt bucket	● ● ●	 1030	Castor Ø 80 mm with thread 8x28 and thread guard	
 1005 A 1005 B 1005 R	25 Lt bucket	● ● ●	 1038	Castor Ø 80 mm with thread 10x15	
 7030 B	22 Lt rect. bucket	●	 1430	Castor Ø 80 mm with expander and thread guard	
 7038	Lid for 22 Lt rect. bucket	●	 1431	Castor Ø 80 mm with plug and thread guard	
 1008	Bottom filter for ALEX/ALEX COMBI		 21012	Castor Ø 125 mm XL without brake with thread 10x15	
 1009/1 1009/2	Support no.1 with castor Ø 80 mm for ALEX Support no.2 with castor Ø 80 mm for ALEX		 1432	Bush for castor with plug (item no. 1431)	
 1009/c-1 1009/c-2	Support no.1 with castor Ø 80 mm for ALEX COMBI Support no.2 with castor Ø 80 mm for ALEX COMBI		 1031 1032	Small bumpers	● ●
 1075	Support with castor Ø 50 mm for MAC		 24021 SKY/MP	Wringer support with plastic reversible handle for SKY	

Code	Description	Color
 24021 SKY/STD	Wringer support without handle for SKY	
 3501 VDM	Roller wringer ELPAROLL	
 4100PA 4100PG 4100PR 4100PVS	Plastic wringer	
 4601	Plastic roller wringer - for semi professional use	
 1071	FAST water hose	
 21037	Threaded locking pin with wings for SKY	





# Bag Holder Trolleys

---

# Bag Holder Trolleys



**Covers.** They can be equipped with plastic covers.



**Practicality.** The cover opening is pedal operated to ensure the best practicality and functionality.



**Bags material.** They can be equipped with 120 or 230 lt bags made of PVC or of sanforized canvas.







Chromium plated steel



Code	Description	Color
SA/X	<b>Folding bag holder trolley chromed with clip</b>	
GRSA/X	1 SA/X trolley structure with 4 castors Ø 80 mm (item no. 1431)	



Code	Description	Color
SA/XT	<b>Folding bag holder trolley chromed with rubber ring</b>	
GRSA/XT	1 SA/XT trolley structure with 4 castors Ø 80 mm (item no. 1431)	

 53x50x104h cm |  3 Pcs/carton 20,7 Kg 0,175 m<sup>3</sup>

 53x50x104h cm |  3 Pcs/carton 20,5 Kg 0,175 m<sup>3</sup>

**Optional** (shown in the picture)

1610 Square lid 

Chromium plated steel



Code	Description	Color
<b>X 2.50.80</b>	<b>Folding bag holder trolley chromed with rubber ring</b>	
GRX	1 X trolley structure with 4 castors Ø 80 mm (item no. 1430)	
1610	1 Square lid	●

Code	Description	Color
<b>XE 2.50.80</b>	<b>Folding bag holder trolley chromed with rubber ring</b>	
GRXE	1 XE trolley structure with 4 castors Ø 80 mm (item no. 1430)	
GR1725XE	1 Extractable bag holder XE with rubber ring	

53x50x104h cm	3 Pcs/carton	26,4 Kg	0,175 m <sup>3</sup>
---------------	--------------	---------	----------------------

53x50x104h cm	3 Pcs/carton	25,2 Kg	0,175 m <sup>3</sup>
---------------	--------------	---------	----------------------

Optional (shown in the picture)

1667	Basket for X/XE	
1730	Metal box X/XE	●

Stainless steel  
(AISI 304)



Code	Description	Color
<b>BIOSTEEL X</b>	<b>Stainless steel trolley BIOSTEEL X</b>	
GRBIOSTEELX	1 BIOSTEEL X stainless steel trolley structure with 4 castors Ø 80 mm (item no. 1430) and bumpers	
1680/G	1 Sanforized canvas bag 230 lt	

Chromium  
plated steel



Code	Description	Color
<b>L 1.50.80</b>	<b>Chromed bag holder trolley</b>	
GR1815	1 Chromed base 50x44 cm with 4 castors Ø 80 mm (item no. 1030) and bumpers	
GR1625	1 Vertical frame with bag holder and rubber ring	
1610	1 Square lid	●
KITMULTIUSO/A	1 Assembling kit for L 1.50.80 - L 1.75.80	

 53x50x104h cm |  2 Pcs/carton 15 Kg 0,175 m<sup>3</sup>

 50x44x102h cm |  2 Pcs/carton 16,5 Kg 0,150 m<sup>3</sup>

Chromium plated steel



Code	Description	Color
<b>L 1.50.80-PED</b>	<b>Bag holder trolley with foot operated cover</b>	
GR1815/PED	1 Chromed base 50x44 cm pedal operated with 4 castors Ø 80 mm (item no. 1030) and bumpers	
GR1625	1 Vertical frame with bag holder and rubber ring	●
GR1610/PED	1 Lid for foot operated trolley	
KITMULTIUSO/C	1 Assembling kit for L 1.50.80-PED	
KITPED	1 Assembling kit for L 1.50.80-PED	

Code	Description	Color
<b>HE</b>	<b>Chromed bag holder trolley</b>	
GR1690	1 Bag support for HE	
1694	1 Drive-shaft HE for fixed castor Ø 200 mm	
1696	2 Fixed castors Ø 200 mm	

 50x44x102h cm |  2 Pcs/carton 16,7 Kg 0,150 m<sup>3</sup>

 55x52x93h cm |  5 Pcs/carton 30 Kg 0,150 m<sup>3</sup>

Chromium  
plated steel



Code	Description	Color
------	-------------	-------

**L 1.75.80-2S Chromed trolley with two bags 120 lt**

- GR1615 1 Chrome base 75x44 cm with 4 castors Ø 80 mm (item no. 1030) and bumpers
- GR16252S 1 Multifunctional vertical frame 2 bags
- KITMULTIUSO/B 1 Assembling kit for L 1.75.80-2S



Code	Description	Color
------	-------------	-------

**JOKER TRIO Chromed trolley TRIO (3x120 lt)**

- GR8201/T 1 Base JOKER TRIO equipped with 4 castors Ø 100 mm (item no. 2034) with expander and bumpers
- GR8202 2 Joker vertical frames
- GR8204 1 Bag holder 70 lt with clips for JOKER
- GR8204/T 1 Double bag-holder with clips for JOKER TRIO
- GR8206 1 Bag support 70 lt JOKER
- KITJOKER/D 1 Assembling kit for JOKER TRIO

 75x44x103h cm |  1 Pc/carton 11 Kg 0,150 m<sup>3</sup>

 115x50x106h cm |  1 Pc/carton 15,2 Kg 0,150 m<sup>3</sup>

**Optional**

- 1610 Square lid
- 2101 KIT PED





Code	Description	Color
<b>IDEABASE 2</b>	<b>Two bag trolley IDEABASE</b>	
21001IDEA/BASE	1 IDEA base equipped with 4 natural rubber castors Ø 100 mm without brake (item no. 21008)	●
21003 B	1 Base end	●
GR21016	1 Rilsan vertical frame with bag holder and rubber ring for IDEABASE	
GR5013/R	1 Rilsan bag holder 120 lt in rilsan equipped with clips and cover holder (item no. 7031) for BIO-R	
KITIDEABASE/A	1 Assembling kit with 1 rubber handle holder (item no. 2255)	

Code	Description	Color
<b>IDEABASE 3</b>	<b>Three bag trolley IDEABASE</b>	
21001IDEA/BASE	1 IDEA base equipped with 4 natural rubber castors Ø 100 mm without brake (item no. 21008)	●
21003 B	1 Base end	●
GR21015	1 Rilsan vertical frame for IDEABASE	
GR5013/R	1 Rilsan bag holder 120 lt in rilsan equipped with clips and cover holder (item no. 7031) for BIO-R	
GR5027/R	1 Bag holder DUOx70 lt in rilsan with clips for BIO-R	
KITIDEABASE/A	1 Assembling kit with 1 rubber handle holder (item no. 2255)	

83x52x105h cm	1 Pc/carton	12,7 Kg	0,225 m <sup>3</sup>
---------------	-------------	---------	----------------------

**Optional** (shown in the picture)









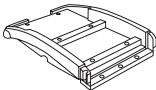
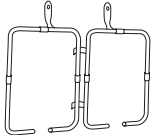
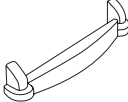

1610	Square lid	●
------	------------	---

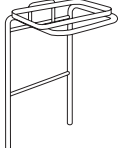
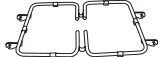
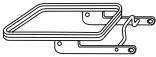
83x52x105h cm	1 Pc/carton	12,6 Kg	0,225 m <sup>3</sup>
---------------	-------------	---------	----------------------

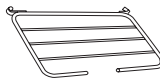

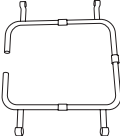
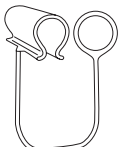









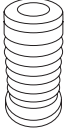
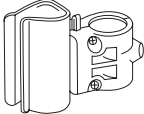

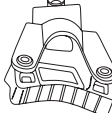
**Optional**





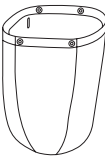



5051/R	Lid for duo bag-holder	●
--------	------------------------	---

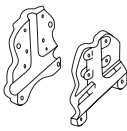

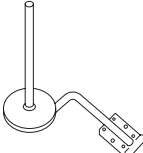
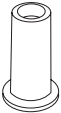
	Code	Description	Color		Code	Description	Color
	21001 B	IDEA base without castors	●		GR5027/R	Bag holder DU0x70 It in rilsan with clips for BIO-R	
	21003 B	Base end	●		GR8204	Bag holder 70 It with clips for JOKER	
	GR21016	Rilsan vertical frame with bag holder and rubber ring for IDEABASE			GR8204/T	Double bag-holder with clips for JOKER TRIO	
	GR1620	Bag holder with rubber ring			1610 1611	Square lid	● ●
	GR1725	Bag holder with rubber ring for X			GR8206	Bag support 70 It JOKER	
	GR1725XE	Extractable bag holder XE with rubber ring			1621	Plastic clip	●
	GR1728	Bag holder with clips for SA/X			1701	Plastic clip with ring	●
	GR1731	Bag holder with elastic ring for SA/XT			1622	Rubber ring large	
	GR5013/R	Rilsan bag holder 120 It equipped with clips and cover holder (item no. 7031) for BIO-R			1712	Basket for buckets for SA/X - SA/XT	

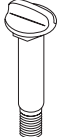

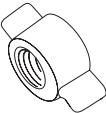
Code	Description	Color	Code	Description	Color
	1667 Basket for X/XE			1696 Fixed castor Ø 200 mm	
	1724 Nylon multi-pocket panel for X/XE			1432 Bush for castor with plug (item no. 1431)	
	KIT2230 Kit handle holder Ø 22 mm with coupling system	●		1694 Drive-shaft HE for fixed castor Ø 200 mm	
	2255 Rubber handle holder with coupling system Ø 22 mm			1031 1032 Small bumpers	● ●
	1030 Castor Ø 80 mm with thread 8x28 and thread guard			1648 Plastic wing screw 6x15	
	1430 Castor Ø 80 mm with expander and thread guard			1680/G Sanforized canvas bag 230 lt	
	1431 Castor Ø 80 mm with plug and thread guard			1685 Nylon bag 120 lt with eyelets for XE	
	2034 Castor Ø 80 mm with expander and thread guard			1630 Multifunctional rod	
	21008 Natural rubber castor Ø 100 mm without brake with thread 10x15			1640 Multifunctional threaded rod	

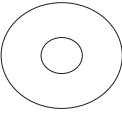
Code	Description	Color
	<b>KIT1735</b> <b>Kit pair fixing plates</b>	
	<b>1750</b> <b>Roll holder with fixing plates SA/X - SA/XT</b>	
	<b>21030 B</b> <b>Plug for base</b>	
	<b>21035 B</b> <b>Threaded pin</b>	
	<b>21036</b> <b>Threaded ring nut</b>	
	<b>4219</b> <b>Washer 6x24</b>	





# Multifunctional Enclosed Plastic Trolleys

---

DMX

58

---

MX

76

# Multifunctional Enclosed Plastic Trolleys



**Separate waste collection.** The two color (blue/yellow) bag holder and the slider equipped with two bag holder clips with ring allow to manage up to three bags for the separate waste collection.



**Easy manoeuvrability.** The pivotal movement of the wheels ensures an easy manoeuvrability of the trolley also in critical situations.



**Doors and bags.** The closing doors can enclose two or three bags for waste collection and have a 90° opening. The trolley can be equipped with net, nylon or PVC bag.







**Easy replacement of the wheels.** During the molding phase, in the base and base extension are inserted the threaded brass bushes that allow the screwing of the wheels. This special system, adopted in Italy only by VDM, allows an easy and fast replacement of the wheels.



**Drawers.** DMX drawers can be opened on both sides, thus allowing two operators to work easily with a single trolley. It is also possible to accommodate the hermetic lid and Tecno Shower dispenser.

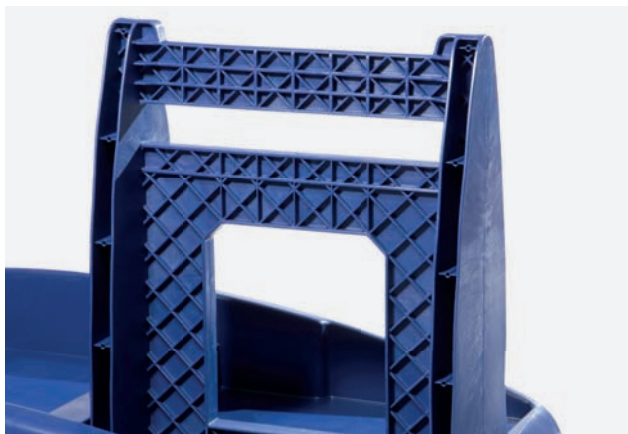

**First quality materials.** Vertical frames in polypropylene copolymer reinforced with AISI 304 stainless steel bars. Wringer support made of 70% polypropylene and 30% glass fiber. This grants the maximum stability during wringing operations.

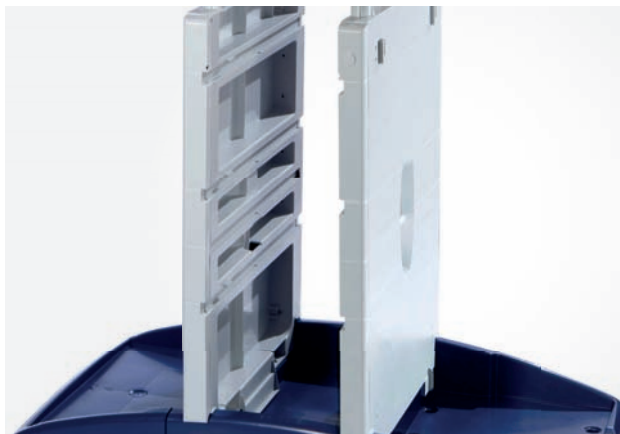





**Safety.** The two and three drawer versions are equipped with a locking system that blocks the whole trolley section with a single lock.



Code	Description	Color
<b>DMX 201.2</b>	<b>Multifunctional enclosed plastic trolley</b>	
21001AB/DMX	1 IDEA/AB base equipped with 4 outdoor soft castors Ø 125 mm (item no. 21027)	●
21003 B	1 Base end	●
25050	1 DMX vertical frame without lock -2 drawers	●
25052	1 DMX vertical frame with lock - 2 drawers	●
25066 A	1x30 lt drawer for DMX	●
25066 R	1x30 lt drawer for DMX	●
2250 BA	1x6 lt bucket	●
2250 RA	1x6 lt bucket	●
23005 BA	1 Bag-holder equipped with 4 handle holders, lid with document holder and sliding device for MX/DMX	●
23004 B	1 Plastic upper end with 3 handle-holders for MX/DMX	●
25064	2 DMX small keys housings	●
23003/1	1 Upper tray for buckets for MX/DMX	●
KITDMX/A	1 Assembling kit for DMX 201	●

Code	Description	Color
<b>DMX 201.3</b>	<b>Multifunctional enclosed plastic trolley</b>	
21001AB/DMX	1 IDEA/AB base equipped with 4 outdoor soft castors Ø 125 mm (item no. 21027)	●
21003 B	1 Base end	●
25051	1 DMX vertical frame without lock -3 drawers	●
25053	1 DMX vertical frame with lock -3 drawers	●
25065 A	1x20 lt drawer for DMX	●
25065 G	1x20 lt drawer for DMX	●
25065 R	1x20 lt drawer for DMX	●
23020 G	1x4 lt bucket	●
23020 R	1x4 lt bucket	●
2250 BA	1x6 lt bucket	●
23005 BA	1 Bag-holder equipped with 4 handle holders, lid with document holder and sliding device for MX/DMX	●
23004 B	1 Plastic upper end with 3 handle-holders for MX/DMX	●
25064	2 DMX small keys housings	●
23003/1	1 Upper tray for buckets for MX/DMX	●
KITDMX/A	1 Assembling kit for DMX 201	●

 83x56x105h cm	 1 Pc/carton	25,5 Kg	0,400 m <sup>3</sup>
---	---	---------	----------------------

 83x56x105h cm	 1 Pc/carton	26 Kg	0,400 m <sup>3</sup>
---	---	-------	----------------------





Code	Description	Color
------	-------------	-------

**DMX 203.2 Multifunctional enclosed plastic trolley**

21001AB/COMPACT	1 IDEA/AB base equipped with 4 outdoor soft castors Ø 125 mm (item no. 21027) and with door stop	●
21003 B	1 Base end	●
25050	1 DMX vertical frame without lock - 2 drawers	●
25052	1 DMX vertical frame with lock - 2 drawers	●
23011N	1 Left door for MX/DMX	○
23012N	1 Right door for MX/DMX	○
25066 A	1x30 lt drawer for DMX	●
25066 R	1x30 lt drawer for DMX	●
2250 BA	1x6 lt bucket	●
2250 RA	1x6 lt bucket	●
23005 BA	1 Bag-holder equipped with 4 handle holders, lid with document holder and sliding device for MX/DMX	●
23004 B	1 Plastic upper end with 3 handle-holders for MX/DMX	●
25064	2 DMX small keys housings	●
23003/1	1 Upper tray for buckets for MX/DMX	●
KITDMX/B	1 Assembling kit for DMX 203-204	●

Code	Description	Color
------	-------------	-------

**DMX 203.3 Multifunctional enclosed plastic trolley**

21001 AB/COMPACT	1 IDEA/AB base equipped with 4 outdoor soft castors Ø 125 mm (item no. 21027) and with door stop	●
21003 B	1 Base end	●
25051	1 DMX vertical frame without lock - 3 drawers	●
25053	1 DMX vertical frame with lock -3 drawers	●
23011N	1 Left door for MX/DMX	○
23012N	1 Right door for MX/DMX	○
25065 A	1x20 lt drawer for DMX	●
25065 G	1x20 lt drawer for DMX	●
25065 R	1x20 lt drawer for DMX	●
23020 G	1x4 lt bucket	●
23020 R	1x4 lt bucket	●
2250 BA	1x6 lt bucket	●
23005 BA	1 Bag-holder equipped with 4 handle holders, lid with document holder and sliding device for MX/DMX	●
23004 B	1 Plastic upper end with 3 handle-holders for MX/DMX	●
25064	2 DMX small keys housings	●
23003/1	1 Upper tray for buckets for MX/DMX	●
KITDMX/B	1 Assembling kit for DMX 203-204	●



 83x56x105h cm |  1 Pc/carton 27,5 Kg 0,400 m<sup>3</sup>



 83x56x105hcm |  1 Pc/carton 28 Kg 0,400 m<sup>3</sup>



Code	Description	Color
<b>DMX 204.2</b>	<b>Multifunctional enclosed plastic trolley</b>	
21001AB/COMPACT	1 IDEA/AB base equipped with 4 outdoor soft castors Ø 125 mm (item no. 21027) and with door stop	●
21003 B	1 Base end	●
25050	1 DMX vertical frame without lock -2 drawers	●
25052	1 DMX vertical frame with lock -2 drawers	●
23011N	1 Left door for MX/DMX	○
23012N	1 Right door for MX/DMX	○
25066 A	1x30 lt drawer for DMX	●
25066 R	1x30 lt drawer for DMX	●
2250 BA	1x6 lt bucket	●
2250 RA	1x6 lt bucket	●
7030 BA	1x22 lt rect. bucket	●
2252	2 Lids for 6 lt bucket	●
7038	1 Lid for 22 lt rect. bucket	●
23005 BA	1 Bag-holder equipped with 4 handle holders, lid with document holder and sliding device for MX/DMX	●
23004 B	1 Plastic upper end with 3 handle-holders for MX/DMX	●
25064	2 DMX small keys housings	●
23003/1	1 Upper tray for buckets for MX/DMX	●
23046	1 Rilsan basket for 22 lt bucket for MX/DMX	●
KITDMX/B	1 Assembling kit for DMX 203-204	●

Code	Description	Color
<b>DMX 204.3</b>	<b>Multifunctional enclosed plastic trolley</b>	
21001AB/COMPACT	1 IDEA/AB base equipped with 4 outdoor soft castors Ø 125 mm (item no. 21027) and with door stop	●
21003 B	1 Base end	●
25051	1 DMX vertical frame without lock -3 drawers	●
25053	1 DMX vertical frame with lock - 3 drawers	●
23011N	1 Left door for MX/DMX	○
23012N	1 Right door for MX/DMX	○
25065 A	1x20 lt drawer for DMX	●
25065 G	1x20 lt drawer for DMX	●
25065 R	1x20 lt drawer for DMX	●
23020 G	1x4 lt bucket	●
23020 R	1x4 lt bucket	●
2250 BA	1x6 lt bucket	●
7030 BA	1x22 lt rect. bucket	●
2252	1 Lid for 6 lt bucket	●
7038	1 Lid for 22 lt rect. bucket	●
23005 BA	1 Bag-holder equipped with 4 handle holders, lid with document holder and sliding device for MX/DMX	●
23004 B	1 Plastic upper end with 3 handle-holders for MX/DMX	●
25064	2 DMX small keys housings	●
23003/1	1 Upper tray for buckets for MX/DMX	●
23046	1 Rilsan basket for 22 lt bucket for MX/DMX	●
KITDMX/B	1 Assembling kit for DMX 203-204	●

 **105x56x105hcm** |  **1 Pc/2 cartons 31 Kg 0,450 m³**

 **105x56x105h cm** |  **1 Pc/2 cartons 31,5 Kg 0,450 m³**



Code	Description	Color
------	-------------	-------

**DMX 301.2 Multifunctional enclosed plastic trolley**

**DMX 301.2 S/P Multifunctional enclosed plastic trolley without wringer**

21001AB/DMX	1 IDEA/AB base equipped with 4 outdoor soft castors Ø 125 mm (item no. 21027)	●
21002AB/DMX	1 Base extension equipped with outdoor soft castor Ø 125 mm (item no. 21027)	●
25050	1 DMX vertical frame without lock - 2 drawers	●
25052	1 DMX vertical frame with lock - 2 drawers	●
25066 A	1x30 lt drawer for DMX	●
25066 R	1x30 lt drawer for DMX	●
21005 BA	1x15 lt bucket for IDEA	●
21005 RA	1x15 lt bucket for IDEA	●
2250 BA	1x6 lt bucket	●
2250 RA	1x6 lt bucket	●
23005 BA	1 Bag-holder equipped with 4 handle holders, lid with document holder and sliding device for MX/DMX	●
23004 B	1 Plastic upper end with 3 handle-holders for MX/DMX	●
25064	2 DMX small keys housings	●
23003/1	1 Upper tray for buckets for MX/DMX	●
23008	1 Plastic wringer support with coupling system for IDEA	●
4100PB	1 Plastic wringer	●
KITDMX/C	1 Assembling kit for DMX 301	●

Code	Description	Color
------	-------------	-------

**DMX 301.3 Multifunctional enclosed plastic trolley**

**DMX 301.3 S/P Multifunctional enclosed plastic trolley without wringer**

21001AB/DMX	1 IDEA/AB base equipped with 4 outdoor soft castors Ø 125 mm (item no. 21027)	●
21002AB/DMX	1 Base extension equipped with outdoor soft castor Ø 125 mm (item no. 21027)	●
25051	1 DMX vertical frame without lock - 3 drawers	●
25053	1 DMX vertical frame with lock - 3 drawers	●
25065 A	1x20 lt drawer for DMX	●
25065 G	1x20 lt drawer for DMX	●
25065 R	1x20 lt drawer for DMX	●
21005 BA	1x15 lt bucket for IDEA	●
21005 RA	1x15 lt bucket for IDEA	●
2250 BA	1x6 lt bucket	●
2250 RA	1x6 lt bucket	●
23005 BA	1 Bag-holder equipped with 4 handle holders, lid with document holder and sliding device for MX/DMX	●
23004 B	1 Plastic upper end with 3 handle-holders for MX/DMX	●
25064	2 DMX small keys housings	●
23003/1	1 Upper tray for buckets for MX/DMX	●
23008	1 Plastic wringer support with coupling system for IDEA	●
4100PB	1 Plastic wringer	●
KITDMX/C	1 Assembling kit for DMX 301	●

110x56x105h cm	<table border="0"> <tr> <td></td> <td>1 Pc/2 cartons</td> <td>29 Kg</td> <td>0,520 m<sup>3</sup></td> </tr> <tr> <td></td> <td>1 Pc/2 cartons</td> <td>26,5 Kg</td> <td>0,520 m<sup>3</sup></td> </tr> </table>		1 Pc/2 cartons	29 Kg	0,520 m <sup>3</sup>		1 Pc/2 cartons	26,5 Kg	0,520 m <sup>3</sup>
	1 Pc/2 cartons	29 Kg	0,520 m <sup>3</sup>						
	1 Pc/2 cartons	26,5 Kg	0,520 m <sup>3</sup>						

110x56x105h cm	<table border="0"> <tr> <td></td> <td>1 Pc/2 cartons</td> <td>29,5 Kg</td> <td>0,520 m<sup>3</sup></td> </tr> <tr> <td></td> <td>1 Pc/2 cartons</td> <td>27 Kg</td> <td>0,520 m<sup>3</sup></td> </tr> </table>		1 Pc/2 cartons	29,5 Kg	0,520 m <sup>3</sup>		1 Pc/2 cartons	27 Kg	0,520 m <sup>3</sup>
	1 Pc/2 cartons	29,5 Kg	0,520 m <sup>3</sup>						
	1 Pc/2 cartons	27 Kg	0,520 m <sup>3</sup>						



Code	Description	Color
------	-------------	-------

**DMX 303.2 Multifunctional enclosed plastic trolley**

**DMX 303.2 S/P Multifunctional enclosed plastic trolley without wringer**

21001AB/DMX	1 IDEA/AB base equipped with 4 outdoor soft castors Ø 125 mm (item no. 21027)	●
21002IDEA/DMX	1 Base extension equipped with outdoor soft castor Ø 125 mm (item no. 21027) and door stop	●
25050	1 DMX vertical frame without lock - 2 drawers	●
25052	1 DMX vertical frame with lock - 2 drawers	●
23011N	1 Left door for MX/DMX	○
23012N	1 Right door for MX/DMX	○
25066 A	1x30 lt drawer for DMX	●
25066 R	1x30 lt drawer for DMX	●
21005 BA	1x15 lt bucket for IDEA	●
21005 RA	1x15 lt bucket for IDEA	●
2250 BA	1x6 lt bucket	●
2250 RA	1x6 lt bucket	●
23005 BA	1 Bag-holder equipped with 4 handle holders, lid with document holder and sliding device for MX/DMX	●
23004 B	1 Plastic upper end with 3 handle-holders for MX/DMX	●
25064	2 DMX small keys housings	●
23003/1	1 Upper tray for buckets for MX/DMX	●
23008	1 Plastic wringer support with coupling system for IDEA	●
4100PB	1 Plastic wringer	●
KITDMX/D	1 Assembling kit for DMX 303	●

Code	Description	Color
------	-------------	-------

**DMX 303.3 Multifunctional enclosed plastic trolley**

**DMX 303.3 S/P Multifunctional enclosed plastic trolley without wringer**

21001AB/DMX	1 IDEA/AB base equipped with 4 outdoor soft castors Ø 125 mm (item no. 21027)	●
21002IDEA/DMX	1 Base extension equipped with outdoor soft castor Ø 125 m (item no. 21027) and door stop	●
25051	1 DMX vertical frame without lock - 3 drawers	●
25053	1 DMX vertical frame with lock - 3 drawers	●
23011N	1 Left door for MX/DMX	○
23012N	1 Right door for MX/DMX	○
25065 A	1x20 lt drawer for DMX	●
25065 G	1x20 lt drawer for DMX	●
25065 R	1x20 lt drawer for DMX	●
21005 BA	1x15 lt bucket for IDEA	●
21005 RA	1x15 lt bucket for IDEA	●
2250 BA	1x6 lt bucket	●
2250 RA	1x6 lt bucket	●
23005 BA	1 Bag-holder equipped with 4 handle holders, lid with document holder and sliding device for MX/DMX	●
23004 B	1 Plastic upper end with 3 handle-holders for MX/DMX	●
25064	2 DMX small keys housings	●
23003/1	1 Upper tray for buckets for MX/DMX	●
23008	1 Plastic wringer support with coupling system for IDEA	●
4100PB	1 Plastic wringer	●
KITDMX/D	1 Assembling kit for DMX 303	●

<b>110x56x105h cm</b>	<b>1 Pc/2 cartons</b>	<b>36,5 Kg</b>	<b>0,520 m<sup>3</sup></b>
	<b>1 Pc/2 cartons</b>	<b>34 Kg</b>	<b>0,520 m<sup>3</sup></b>

<b>110x56x105h cm</b>	<b>1 Pc/2 cartons</b>	<b>37 Kg</b>	<b>0,520 m<sup>3</sup></b>
	<b>1 Pc/2 cartons</b>	<b>34,5 Kg</b>	<b>0,520 m<sup>3</sup></b>



Code	Description	Color
------	-------------	-------

**DMX 304.2 Multifunctional enclosed plastic trolley**

21001AB/DMX	1 IDEA/AB base equipped with 4 outdoor soft castors Ø 125 mm (item no. 21027)	●
21002IDEA/DMX	1 Base extension equipped with outdoor soft castor Ø 125 mm (item no. 21027) and door stop	●
25050	1 DMX vertical frame without lock - 2 drawers	●
25052	1 DMX vertical frame with lock - 2 drawers	●
23011N	1 Left door for MX/DMX	○
23012N	1 Right door for MX/DMX	○
25066 A	1x30 lt drawer for DMX	●
25066 R	1x30 lt drawer for DMX	●
23020 G	1x4 lt bucket	●
23020 R	1x4 lt bucket	●
2250 BA	1x6 lt bucket	●
7030 RA	1x22 lt rect. bucket	●
7038	1 Lid for 22 lt rect. bucket	●
23005 BA	1 Bag-holder equipped with 4 handle holders, lid with document holder and sliding device for MX/DMX	●
23004 B	1 Plastic upper end with 3 handle-holders for MX/DMX	●
25064	2 DMX small keys housings	●
23003/1	1 Upper tray for buckets for MX/DMX	●
KITDMX/E	1 Assembling kit for DMX 304-305-501	●

Code	Description	Color
------	-------------	-------

**DMX 304.3 Multifunctional enclosed plastic trolley**

21001AB/DMX	IDEA/AB base equipped with 4 outdoor soft castors Ø 125 mm (item no. 21027)	●
21002IDEA/DMX	1 Base extension equipped with outdoor soft castor Ø 125 mm (item no. 21027) and door stop	●
25051	1 DMX vertical frame without lock - 3 drawers	●
25053	1 DMX vertical frame with lock - 3 drawers	●
23011N	1 Left door for MX/DMX	○
23012N	1 Right door for MX/DMX	○
25065 A	1x20 lt drawer for DMX	●
25065 G	1x20 lt drawer for DMX	●
25065 R	1x20 lt drawer for DMX	●
23020 G	1x4 lt bucket	●
23020 R	1x4 lt bucket	●
2250 BA	1x6 lt bucket	●
7030 RA	1x22 lt rect. bucket	●
7038	1 Lid for 22 lt rect. bucket	●
23005 BA	1 Bag-holder equipped with 4 handle holders, lid with document holder and sliding device for MX/DMX	●
23004 B	1 Plastic upper end with 3 handle-holders for MX/DMX	●
25064	2 DMX small keys housings	●
23003/1	1 Upper tray for buckets for MX/DMX	●
KITDMX/E	1 Assembling kit for DMX 304-305-501	●

110x56x105h cm | 1 Pc/2 cartons 29 Kg 0,520 m³

110x56x105h cm | 1 Pc/2 cartons 29,5 Kg 0,520 m³





Code	Description	Color
------	-------------	-------

**DMX 305.2 Multifunctional enclosed plastic trolley**

**DMX 305.2 S/P Multifunctional enclosed plastic trolley without wringer**

21001AB/DMX	1 IDEA/AB base equipped with 4 outdoor soft castors Ø 125 mm (item no. 21027)	●
21002IDEA/DMX	1 Base extension equipped with outdoor soft castor Ø 125 mm (item no. 21027) and door stop	●
25050	1 DMX vertical frame without lock - 2 drawers	●
25052	1 DMX vertical frame with lock - 2 drawers	●
23011N	1 Left door for MX/DMX	○
23012N	1 Right door for MX/DMX	○
25066 A	1x30 lt drawer for DMX	●
25066 R	1x30 lt drawer for DMX	●
2250 BA	1x6 lt bucket	●
2250 RA	1x6 lt bucket	●
23005 BA	1 Bag-holder equipped with 4 handle holders, lid with document holder and sliding device for MX/DMX	●
23004 B	1 Plastic upper end with 3 handle-holders for MX/DMX	●
25064	2 DMX small keys housings	●
23003/1	1 Upper tray for buckets for MX/DMX	●
MAC 50G+P	1 Mopping unit mono 20 lt	●
4635	1x8 lt bucket	●
KITDMX/E	1 Assembling kit for DMX 304-305-501	●

Code	Description	Color
------	-------------	-------

**DMX 305.3 Multifunctional enclosed plastic trolley**

**DMX 305.3 S/P Multifunctional enclosed plastic trolley without wringer**

21001AB/DMX	1 IDEA/AB base equipped with 4 outdoor soft castors Ø 125 mm (item no. 21027)	●
21002IDEA/DMX	1 Base extension equipped with outdoor soft castor Ø 125 mm (item no. 21027) and door stop	●
25051	1 DMX vertical frame without lock - 3 drawers	●
25053	1 DMX vertical frame with lock - 3 drawers	●
23011N	1 Left door for MX/DMX	○
23012N	1 Right door for MX/DMX	○
25065 A	1x20 lt drawer for DMX	●
25065 R	1x20 lt drawer for DMX	●
23020 G	1x4 lt bucket	●
23020 R	1x4 lt bucket	●
2250 BA	1x6 lt bucket	●
23005 BA	1 Bag-holder equipped with 4 handle holders, lid with document holder and sliding device for MX/DMX	●
23004 B	1 Plastic upper end with 3 handle-holders for MX/DMX	●
25064	2 DMX small keys housings	●
23003/1	1 Upper tray for buckets for MX/DMX	●
MAC 50G+P	1 Mopping unit mono 20 lt	●
4635	1x8 lt bucket	●
KITDMX/E	1 Assembling kit for DMX 304-305-501	●

110x56x105h cm	<table border="0"> <tr> <td> 1 Pc/2 cartons</td> <td>31 Kg</td> <td>0,520 m<sup>3</sup></td> </tr> <tr> <td> 1 Pc/2 cartons</td> <td>28,5 Kg</td> <td>0,520 m<sup>3</sup></td> </tr> </table>	1 Pc/2 cartons	31 Kg	0,520 m <sup>3</sup>	1 Pc/2 cartons	28,5 Kg	0,520 m <sup>3</sup>
1 Pc/2 cartons	31 Kg	0,520 m <sup>3</sup>					
1 Pc/2 cartons	28,5 Kg	0,520 m <sup>3</sup>					

110x56x105h cm	<table border="0"> <tr> <td> 1 Pc/2 cartons</td> <td>31,5 Kg</td> <td>0,520 m<sup>3</sup></td> </tr> <tr> <td> 1 Pc/2 cartons</td> <td>29 Kg</td> <td>0,520 m<sup>3</sup></td> </tr> </table>	1 Pc/2 cartons	31,5 Kg	0,520 m <sup>3</sup>	1 Pc/2 cartons	29 Kg	0,520 m <sup>3</sup>
1 Pc/2 cartons	31,5 Kg	0,520 m <sup>3</sup>					
1 Pc/2 cartons	29 Kg	0,520 m <sup>3</sup>					



Code	Description	Color
------	-------------	-------

**DMX 401.2 Multifunctional enclosed plastic trolley**

21001AB/DMX	1 IDEA/AB base equipped with 4 outdoor soft castors Ø 125 mm (item no. 21027)	●
21002AB/DMX	1 Base extension equipped with outdoor soft castor Ø 125 mm (item no. 21027)	●
25050	1 DMX vertical frame without lock - 2 drawers	●
25052	1 DMX vertical frame with lock - 2 drawers	●
25066 A	1x30 lt drawer for DMX	●
25066 R	1x30 lt drawer for DMX	●
2250 BA	1x6 lt bucket	●
2250 RA	1x6 lt bucket	●
23005 BA	2 Bag-holders equipped with 4 handle holders, lid with document holder and sliding device for MX/DMX	●
25064	2 DMX small keys housings	●
23003/1	1 Upper tray for buckets for MX/DMX	●
1677 B	1 Nylon bag 120 lt (72x100 cm)	●
1677 R	1 Nylon bag 120 lt (72x100 cm)	●
KITDMX/F	1 Assembling kit for DMX 401	●

Code	Description	Color
------	-------------	-------

**DMX 401.3 Multifunctional enclosed plastic trolley**

21001AB/DMX	1 IDEA/AB base equipped with 4 outdoor soft castors Ø 125 mm (item no. 21027)	●
21002AB/DMX	1 Base extension equipped with outdoor soft castor Ø 125 mm (item no. 21027)	●
25051	1 DMX vertical frame without lock - 3 drawers	●
25053	1 DMX vertical frame with lock - 3 drawers	●
25065 A	1x20 lt drawer for DMX	●
25065 G	1x20 lt drawer for DMX	●
25065 R	1x20 lt drawer for DMX	●
23020 G	1x4 lt bucket	●
23020 R	1x4 lt bucket	●
2250 BA	1x6 lt bucket	●
23005 BA	2 Bag-holders equipped with 4 handle holders, lid with document holder and sliding device for MX/DMX	●
25064	2 DMX small keys housings	●
23003/1	1 Upper tray for buckets for MX/DMX	●
1677 B	1 Nylon bag 120 lt (72x100 cm)	●
1677 R	1 Nylon bag 120 lt (72x100 cm)	●
KITDMX/F	1 Assembling kit for DMX 401	●



110x56x105h cm | 1 Pc/2 cartons 26,5 Kg 0,410 m<sup>3</sup>



110x56x105h cm | 1 Pc/2 cartons 27 Kg 0,410 m<sup>3</sup>



Code	Description	Color
<b>DMX 403.2</b>	<b>Multifunctional enclosed plastic trolley</b>	
21001AB/DMX	1 IDEA/AB base equipped with 4 outdoor soft castors Ø 125 mm (item no. 21027)	●
21002IDEA/DMX	1 Base extension equipped with outdoor soft castor Ø 125 mm (item no. 21027) and door stop	●
25050	1 DMX vertical frame without lock - 2 drawers	●
25052	1 DMX vertical frame with lock - 2 drawers	●
23011N	2 Left doors for MX/DMX	○
23012N	2 Right doors for MX/DMX	○
25066 A	1x30 lt drawer for DMX	●
25066 R	1x30 lt drawer for DMX	●
2250 BA	1x6 lt bucket	●
2250 RA	1x6 lt bucket	●
23005 BA	2 Bag-holders equipped with 4 handle holders, lid with document holder and sliding device for MX/DMX	●
25064	2 DMX small keys housings	●
23003/1	1 Upper tray for buckets for MX/DMX	●
1677 B	1 Nylon bag 120 lt (72x100 cm)	●
1677 R	1 Nylon bag 120 lt (72x100 cm)	●
KITDMX/G	1 Assembling kit for DMX 403	●

Code	Description	Color
<b>DMX 403.3</b>	<b>Multifunctional enclosed plastic trolley</b>	
21001AB/DMX	1 IDEA/AB base equipped with 4 outdoor soft castors Ø 125 mm (item no. 21027)	●
21002IDEA/DMX	1 Base extension equipped with outdoor soft castor Ø 125 mm (item no. 21027) and door stop	●
25051	1 DMX vertical frame without lock - 3 drawers	●
25053	1 DMX vertical frame with lock - 3 drawers	●
23011N	2 Left doors for MX/DMX	○
23012N	2 Right doors for MX/DMX	○
25065 A	1x20 lt drawer for DMX	●
25065 G	1x20 lt drawer for DMX	●
25065 R	1x20 lt drawer for DMX	●
23020 G	1x4 lt bucket	●
23020 R	1x4 lt bucket	●
2250 BA	1x6 lt bucket	●
23005 BA	2 Bag-holders equipped with 4 handle holders, lid with document holder and sliding device for MX/DMX	●
25064	2 DMX small keys housings	●
23003/1	1 Upper tray for buckets for MX/DMX	●
1677 B	1 Nylon bag 120 lt (72x100 cm)	●
1677 R	1 Nylon bag 120 lt (72x100 cm)	●
KITDMX/G	1 Assembling kit for DMX 403	●

 **110x56x105h cm** |  **1 Pc/3 cartons** **34,5 Kg** **0,540 m<sup>3</sup>**

 **110x56x105h cm** |  **1 Pc/3 cartons** **35 Kg** **0,540 m<sup>3</sup>**



Code	Description	Color
------	-------------	-------

**DMX 500.2.20 Multifunctional enclosed plastic trolley**

21001AB/DMX	1 IDEA/AB base equipped with 4 outdoor soft castors Ø 125 mm (item no. 21027)	●
21002IDEA/DMX	1 Base extension equipped with outdoor soft castor Ø 125 mm (item no. 21027) and door stop	●
25050	1 DMX vertical frame without lock - 2 drawers	●
25052	1 DMX vertical frame with lock - 2 drawers	●
23011N	1 Left door for MX/DMX	○
23012N	1 Right door for MX/DMX	○
25066 A	1x30 lt drawer for DMX	●
25066 R	1x30 lt drawer for DMX	●
25065/P	2x20 lt drawer with bumpers	●
23020 G	1x4 lt bucket	●
23020 R	1x4 lt bucket	●
2250 BA	1x6 lt bucket	●
23005 BA	1 Bag-holder equipped with 4 handle holders, lid with document holder and sliding device for MX/DMX	●
23004 B	1 Plastic upper end with 3 handle-holders for MX/DMX	●
25064	2 DMX small keys housings	●
23003/1	1 Upper tray for buckets for MX/DMX	●
GR23085	1 Rilsan support for 22 lt bucket for MX/DMX	●
KITDMX/H	1 Assembling kit for DMX 500	●

Code	Description	Color
------	-------------	-------

**DMX 500.2.30 Multifunctional enclosed plastic trolley**

21001AB/DMX	1 IDEA/AB base equipped with 4 outdoor soft castors Ø 125 mm (item no. 21027)	●
21002IDEA/DMX	1 Base extension equipped with outdoor soft castor Ø 125 mm (item no. 21027) and door stop	●
25050	1 DMX vertical frame without lock - 2 drawers	●
25052	1 DMX vertical frame with lock - 2 drawers	●
23011N	1 Left door for MX/DMX	○
23012N	1 Right door for MX/DMX	○
25066 A	1x30 lt drawer for DMX	●
25066 R	1x30 lt drawer for DMX	●
25066/P	2x30 lt drawer with bumpers	●
23020 G	1x4 lt bucket	●
23020 R	1x4 lt bucket	●
2250 BA	1x6 lt bucket	●
23005 BA	1 Bag-holder equipped with 4 handle holders, lid with document holder and sliding device for MX/DMX	●
23004 B	1 Plastic upper end with 3 handle-holders for MX/DMX	●
25064	2 DMX small keys housings	●
23003/1	1 Upper tray for buckets for MX/DMX	●
GR23085	1 Rilsan support for 22 lt bucket for MX/DMX	●
KITDMX/H	1 Assembling kit for DMX 500	●

110x56x105h cm	1 Pc/2 cartons	36,5 Kg	0,520 m <sup>3</sup>
----------------	----------------	---------	----------------------

110x56x105h cm	1 Pc/2 cartons	37 Kg	0,520 m <sup>3</sup>
----------------	----------------	-------	----------------------





Code	Description	Color
<b>DMX 500.3.20</b>	<b>Multifunctional enclosed plastic trolley</b>	
21001AB/DMX	1 IDEA/AB base equipped with 4 outdoor soft castors Ø 125 mm (item no. 21027)	●
21002IDEA/DMX	1 Base extension equipped with outdoor soft castor Ø 125 mm (item no. 21027) and door stop	●
25051	1 DMX vertical frame without lock - 3 drawers	●
25053	1 DMX vertical frame with lock - 3 drawers	●
23011N	1 Left door for MX/DMX	○
23012N	1 Right door for MX/DMX	○
25065 A	1x20 lt drawer for DMX	●
25065 G	1x20 lt drawer for DMX	●
25065 R	1x20 lt drawer for DMX	●
25065/P	2x20 lt drawers with bumpers	●
23020 G	1x4 lt bucket	●
23020 R	1x4 lt bucket	●
2250 BA	1x6 lt bucket	●
23005 BA	1 Bag-holder equipped with 4 handle holders, lid with document holder and sliding device for MX/DMX	●
23004 B	1 Plastic upper end with 3 handle-holders for MX/DMX	●
25064	2 DMX small keys housings	●
23003/1	1 Upper tray for buckets for MX/DMX	●
GR23085	1 Rilsan support for 22 lt bucket for MX/DMX	●
KITDMX/H	1 Assembling kit for DMX 500	

Code	Description	Color
<b>DMX 500.3.30</b>	<b>Multifunctional enclosed plastic trolley</b>	
21001AB/DMX	1 IDEA/AB base equipped with 4 outdoor soft castors Ø 125 mm (item no. 21027)	●
21002IDEA/DMX	1 Base extension equipped with outdoor soft castor Ø 125 mm (item no. 21027) and door stop	●
25051	1 DMX vertical frame without lock - 3 drawers	●
25053	1 DMX vertical frame with lock - 3 drawers	●
23011N	1 Left door for MX/DMX	○
23012N	1 Right door for MX/DMX	○
25065 A	1x20 lt drawer for DMX	●
25065 G	1x20 lt drawer for DMX	●
25065 R	1x20 lt drawer for DMX	●
25066/P	2x20 lt drawers with bumpers	●
23020 G	1x4 lt bucket	●
23020 R	1x4 lt bucket	●
2250 BA	1x6 lt bucket	●
23005 BA	1 Bag-holder equipped with 4 handle holders, lid with document holder and sliding device for MX/DMX	●
23004 B	1 Plastic upper end with 3 handle-holders for MX/DMX	●
25064	2 DMX small keys housings	●
23003/1	1 Upper tray for buckets for MX/DMX	●
GR23085	1 Rilsan support for 22 lt bucket for MX/DMX	●
KITDMX/H	1 Assembling kit for DMX 500	

**110x56x105h cm** | **1 Pc/2 cartons** **37 Kg** **0,520 m³**

**110x56x105h cm** | **1 Pc/2 cartons** **37,5 Kg** **0,520 m³**



Code	Description	Color
------	-------------	-------

**DMX 500.2 Multifunctional enclosed plastic trolley**

21001AB/DMX	1 IDEA/AB base equipped with 4 outdoor soft castors Ø 125 mm (item no. 21027)	●
21002IDEA/DMX	1 Base extension equipped with outdoor soft castor Ø 125 mm (item no. 21027) and door stop	●
25050	1 DMX vertical frame without lock - 2 drawers	●
25052	1 DMX vertical frame with lock - 2 drawers	●
23011N	1 Left door for MX/DMX	○
23012N	1 Right door for MX/DMX	○
25066 A	1x30 lt drawer for DMX	●
25066 R	1x30 lt drawer for DMX	●
23020 G	1x4 lt bucket	●
23020 R	1x4 lt bucket	●
2250 BA	1x6 lt bucket	●
7030 BA	1x22 lt rect. bucket	●
7030 RA	1x22 lt rect. bucket	●
7038	2 Lids for 22 lt rect. bucket	●
23005 BA	1 Bag-holder equipped with 4 handle holders, lid with document holder and sliding device for MX/DMX	●
23004 B	1 Plastic upper end with 3 handle-holders for MX/DMX	●
25064	2 DMX small keys housings	●
23003/1	1 Upper tray for buckets for MX/DMX	●
GR23085	1 Rilsan support for 22 lt bucket for MX/DMX	●
7080	1 Tecno-Shower dispenser	●
KITDMX/H	1 Assembling kit for DMX 500	●

Code	Description	Color
------	-------------	-------

**DMX 500.3 Multifunctional enclosed plastic trolley**

21001AB/DMX	1 IDEA/AB base equipped with 4 outdoor soft castors Ø 125 mm (item no. 21027)	●
21002IDEA/DMX	1 Base extension equipped with outdoor soft castor Ø 125 mm (item no. 21027) and door stop	●
25051	1 DMX vertical frame without lock - 3 drawers	●
25053	1 DMX vertical frame with lock - 3 drawers	●
23011N	1 Left door for MX/DMX	○
23012N	1 Right door for MX/DMX	○
25065 A	1x20 lt drawer for DMX	●
25065 G	1x20 lt drawer for DMX	●
25065 R	1x20 lt drawer for DMX	●
23020 G	1x4 lt bucket	●
23020 R	1x4 lt bucket	●
2250 BA	1x6 lt bucket	●
7030 BA	1x22 lt rect. bucket	●
7030 RA	1x22 lt rect. bucket	●
7038	2 Lids for 22 lt rect. bucket	●
23005 BA	1 Bag-holder equipped with 4 handle holders, lid with document holder and sliding device for MX/DMX	●
23004 B	1 Plastic upper end with 3 handle-holders for MX/DMX	●
25064	2 DMX small keys housings	●
23003/1	1 Upper tray for buckets for MX/DMX	●
GR23085	1 Rilsan support for 22 lt bucket for MX/DMX	●
7080	1 Tecno-Shower dispenser	●
KITDMX/H	1 Assembling kit for DMX 500	●

110x56x105h cm | 1 Pc/2 cartons 36,5 Kg 0,520 m³

110x56x105h cm | 1 Pc/2 cartons 37 Kg 0,520 m³















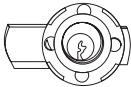
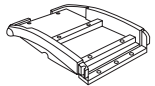

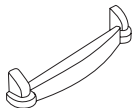
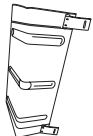
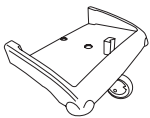

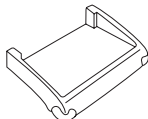
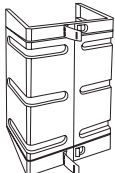

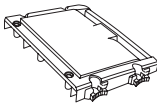

Code	Description	Color
<b>DMX 501.2</b>	<b>Multifunctional enclosed plastic trolley</b>	
21001AB/DMX	1 IDEA/AB base equipped with 4 outdoor soft castors Ø 125 mm (item no. 21027)	●
21002IDEA/DMX	1 Base extension equipped with outdoor soft castor Ø 125 mm (item no. 21027) and door stop	●
25050	1 DMX vertical frame without lock - 2 drawers	●
25052	1 DMX vertical frame with lock - 2 drawers	●
23011N	1 Left door for MX/DMX	○
23012N	1 Right door for MX/DMX	○
25066 A	1x30 lt drawer for DMX	●
25066 R	1x30 lt drawer for DMX	●
23020 G	1x4 lt bucket	●
23020 R	1x4 lt bucket	●
2250 BA	1x6 lt bucket	●
7030 BA	1x22 lt rect. bucket	●
7030 RA	1x22 lt rect. bucket	●
7038	2 Lids for 22 lt rect. bucket	●
23005 BA	1 Bag-holder equipped with 4 handle holders, lid with document holder and sliding device for MX/DMX	●
23004 B	1 Plastic upper end with 3 handle-holders for MX/DMX	●
25064	2 DMX small keys housings	●
23003/1	1 Upper tray for buckets for MX/DMX	●
GR23078	1 Rilsan frame bucket holder trolley	●
7080	1 Tecno-Shower dispenser	●
KITDMX/E	1 Assembling kit for DMX 304-305-501	●

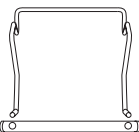
Code	Description	Color
<b>DMX 501.3</b>	<b>Multifunctional enclosed plastic trolley</b>	
21001AB/DMX	1 IDEA/AB base equipped with 4 outdoor soft castors Ø 125 mm (item no. 21027)	●
21002IDEA/DMX	1 Base extension equipped with outdoor soft castor Ø 125 mm (item no. 21027) and door stop	●
25051	1 DMX vertical frame without lock - 3 drawers	●
25053	1 DMX vertical frame with lock - 3 drawers	●
23011N	1 Left door for MX/DMX	○
23012N	1 Right door for MX/DMX	○
25065 A	1x20 lt drawer for DMX	●
25065 G	1x20 lt drawer for DMX	●
25065 R	1x20 lt drawer for DMX	●
23020 G	1x4 lt bucket	●
23020 R	1x4 lt bucket	●
2250 BA	1x6 lt bucket	●
7030 BA	1x22 lt rect. bucket	●
7030 RA	1x22 lt rect. bucket	●
7038	2 Lids for 22 lt rect. bucket	●
23005 BA	1 Bag-holder equipped with 4 handle holders, lid with document holder and sliding device for MX/DMX	●
23004 B	1 Plastic upper end with 3 handle-holders for MX/DMX	●
25064	2 DMX small keys housings	●
23003/1	1 Upper tray for buckets for MX/DMX	●
GR23078	1 Rilsan frame bucket holder trolley	●
7080	1 Tecno-Shower dispenser	●
KITDMX/E	1 Assembling kit for DMX 304-305-501	●

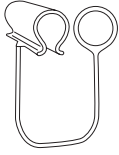
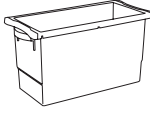

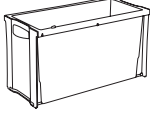
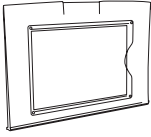
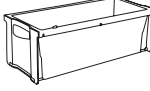
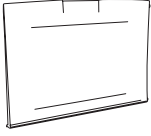

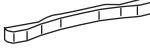
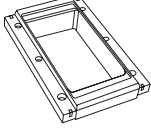
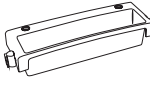
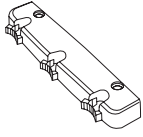

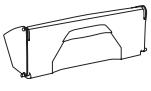
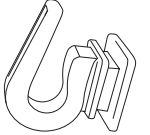
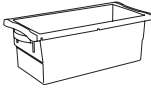
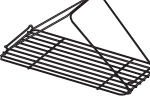
**110x56x105h cm** | **1 Pc/2 cartons** **38 Kg** **0,660 m<sup>3</sup>**



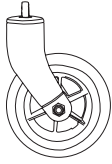
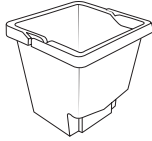

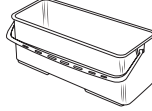
**110x56x105h cm** | **1 Pc/2 cartons** **38,5 Kg** **0,660 m<sup>3</sup>**

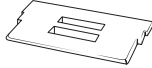
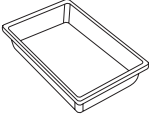
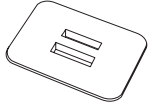
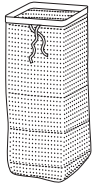
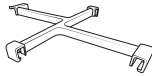
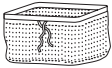
Code	Description	Color	Code	Description	Color
 21001 AB/DMX	IDEA/AB base equipped with 4 outdoor soft castors Ø 125 mm (item no. 21027)	●	 25051	DMX vertical frame without lock - 3 drawers	
 21001 AB/COMPACT	IDEA/AB base equipped with 4 outdoor soft castors Ø 125 mm (item no. 21027) and with door stop	●	 23013	Lock for MX-DMX	
 21001 VS	IDEA/AB base without castors	●	 23014	Key for lock MX and DMX	
 21003 B	Base end	●	 23011N	Left door for MX/DMX	○
 21002 IDEA/DMX	Base extension equipped with outdoor soft castor Ø 125 mm (item no. 21027) and door stop	●	 23012N	Right door for MX/DMX	○
 21002 B	Base extension without castor	●	 23010 N	Complete set of doors MX/DMX	○
 25052	DMX vertical frame with lock - 2 drawers		 23005 BA	Bag-holder equipped with 4 handle holders, lid with document holder and sliding device for MX/DMX	●
 25053	DMX vertical frame with lock - 3 drawers		 23005/100B	Bag-holder without lid equipped with 4 handle holders for MX/DMX	●
 25050	DMX vertical frame without lock - 2 drawers		 23100	Roll holder for bag holder	

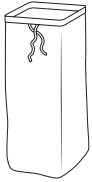
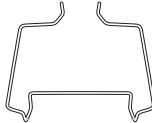
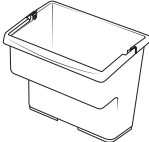
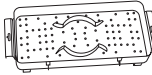
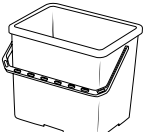
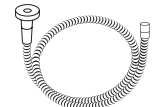
Code	Description	Color	Code	Description	Color
	1701 Plastic clip with ring	●		25066/P 30 Lt drawer with bumpers	
	2709 Plastic device with clips for plastic bag holder	●		25066 A 25066 G 25066 R 25066 V	● ● ● ●
	23006 B Lid with transparent document holder for plastic bag-holder	●		25065 A 25065 G 25065 R 25065 V	● ● ● ●
	23006/N Lid without transparent document holder for plastic bag-holder	●		25060	●
	KIT23030 Rubber handle holder kit			25067	○
	23003/1 Upper tray for buckets for MX/DMX	●		23024	●
	23004 B Plastic upper end with 3 handle-holders for MX/DMX	●		23046	
	25064 DMX small keys housing	●		2231/G	●
	25065/P 20 Lt drawer with guides and bumpers			7032	

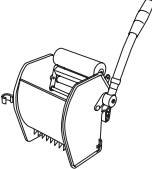
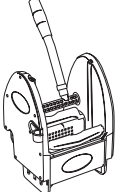
Code	Description	Color	Code	Description	Color
	4260/2 Sign panel (SLIPPERY FLOOR / WET FLOOR)			24060 Castor Ø 100 mm with thread 10x15	
	21035 B Threaded pin	●		24061 Castor Ø 100 mm XL without brake with thread 10x15	
	2230/DMX Handle holder without coupling for bottles basket	○		24062 Castor Ø 100 mm XL with brake with thread 10x15	
	23008 Plastic wringer support with coupling system for IDEA	●		21012 Castor Ø 125 mm XL without brake with thread 10x15	
	GR23085 Rilsan support for 22 lt bucket for MX/DMX			21013 Castor Ø 125 mm with brake with thread 10x15	
	23000 KIT Rilsan tray holder kit with: - rilsan extension - plastic tray for MX (item no. 23015 GR)			21008 Natural rubber castor Ø 100 mm without brake with thread 10x15	
	23016 KIT Rilsan tray-holder kit with: - rilsan tray-holder (item no.23016) - plastic tray for MX (item no. 23015 GR)			21009 Natural rubber castor Ø 100 mm with brake with thread 10x15	
	23023 KIT Rilsan bucket-holder kit with: - 2x4lt rilsan bucket-holder - hinges right (item no. 23070), left (item no. 23071) - 4 screws (item no. 4221)			21006 Natural rubber castor Ø 125 mm without brake with thread 10x15	
	24057 KIT Rilsan VELBOX kit with: - rilsan VELBOX support - hinges right (item no. 23070), left (item no. 23071) - 4 screws (item no. 4221)			21007 Natural rubber castor Ø 125 mm with brake with thread 10x15	

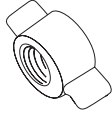
Code	Description	Color	Code	Description	Color
	21027 Outdoor soft castor Ø 125 mm			21005 BA 21005 RA 15 Lt bucket for IDEA	● ●
	21028 Outdoor soft castor Ø 125 mm spec. without brake (to be used with item no. 21029 only)			7030 BA 7030 RA 22 Lt rect. bucket	● ●
	21029 Outdoor soft castor Ø 125 mm spec. with brake (to be used with item no. 21028 only)			23021 Lid for 4 Lt bucket	●
	23015 GR Tray MX	●		2252 Lid for 6 Lt bucket	●
	23095 Net bag 70 Lt with closing string			2253 Bottles divider for 6 Lt bucket	●
	23097 Net bag for 22 Lt bucket with closing string			7038 Lid for 22 Lt rect. bucket	●
	1677 B 1677 R Nylon bag 120 Lt (72x100 cm)	● ●		7079 Rilsan support for dispenser Tecno-Shower	
	23020 B 23020 G 23020 R 23020 VS 4 Lt bucket	● ● ● ●		7080 Tecno-Shower dispenser	●
	2250 BA 2250 G 2250 RA 2250 VS 6 Lt bucket	● ● ● ●		1071 FAST water hose	

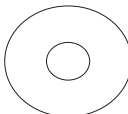
	Code	Description	Color
	3501 VDM	Roller wringer ELPAROLL	
	4100PB	Plastic wringer	●
	21030 B	Plug for base	●
	21036	Threaded ring nut	●
	1648	Plastic wing screw 6x15	
	4219	Washer 6x24	





Code	Description	Color
<b>MX 100</b>	<b>Multifunctional enclosed plastic trolley</b>	
<b>MX 100 S/P</b>	<b>Multifunctional enclosed plastic trolley without wringer</b>	
21001IDEA/PL	1 IDEA base equipped with 4 castors Ø 100 mm (item no. 24060)	●
21003 B	1 Base end	●
23002/100	1 Vertical frame for MX 100	○
23020 G	1x4 lt bucket	●
23020 R	1x4 lt bucket	●
21005 B	1x15 lt bucket for IDEA	●
21005 R	1x15 lt bucket for IDEA	●
23005/100 B	1 Bag-holder without lid equipped with 4 handle holders for MX/DMX	●
23025	1 Basket for buckets without handle holder and hook for MX 100	●
23008	1 Plastic wringer support with coupling system for IDEA	●
4100PB	1 Plastic wringer	●
KITMX/B	1 Assembling kit for MX 100	●

Code	Description	Color
<b>MX 200</b>	<b>Multifunctional enclosed plastic trolley</b>	
21001IDEA/BASE	1 IDEA base equipped with 4 natural rubber castors Ø 100 mm without brake (item no. 21008)	●
21003 B	1 Base end	●
23002	2 Vertical frames for MX	○
2250 B	1x6 lt bucket	●
2250 R	1x6 lt bucket	●
23005 B	1 Bag-holder equipped with 4 handle holders, lid with document holder and sliding device for MX/DMX	●
23004 B	1 Plastic upper end with 3 handle-holders for MX/DMX	●
23003/1	1 Upper tray for buckets for MX/DMX	●
23015 GR	1 Tray MX	○
KITMX/C	1 Assembling kit for MX 200	○

83x56x105h cm	1 Pc/carton	21 Kg	0,250 m <sup>3</sup>
	1 Pc/carton	18,5 Kg	0,250 m <sup>3</sup>

83x56x105h cm	1 Pc/carton	19 Kg	0,240 m <sup>3</sup>
---------------	-------------	-------	----------------------



Code	Description	Color
------	-------------	-------

**MX 201 Multifunctional enclosed plastic trolley**

21001IDEA/BASE	1 IDEA base equipped with 4 natural rubber castors Ø 100 mm without brake (item no. 21008)	●
21003 B	1 Base end	●
23002	2 Vertical frames for MX	○
23007 B	2 Central doors MX with lock (without key)	●
2250 B	1x6 lt bucket	●
2250 R	1x6 lt bucket	●
23005 B	1 Bag-holder equipped with 4 handle holders, lid with document holder and sliding device for MX/DMX	●
23004 B	1 Plastic upper end with 3 handle-holders for MX/DMX	●
23003/1	1 Upper tray for buckets for MX/DMX	●
23015 GR	1 Tray MX	○
KITMX/D	1 Assembling kit for MX 201	○

Code	Description	Color
------	-------------	-------

**MX 202 Multifunctional enclosed plastic trolley**

21001IDEA/MX	1 IDEA base equipped with 4 natural rubber castors Ø 100 mm without brake (item no. 21008) and door stop	●
21003 B	1 Base end	●
23002	2 Vertical frames for MX	○
23011N	1 Left door for MX/DMX	○
23012N	1 Right door for MX/DMX	○
2250 B	1x6 lt bucket	●
2250 R	1x6 lt bucket	●
23005 B	1 Bag-holder equipped with 4 handle holders, lid with document holder and sliding device for MX/DMX	●
23004 B	1 Plastic upper end with 3 handle-holders for MX/DMX	●
23003/1	1 Upper tray for buckets for MX/DMX	●
23015 GR	1 Tray MX	○
KITMX/F	1 Assembling kit for MX 202	○

83x56x105h cm	1 Pc/carton	24 Kg	0,240 m <sup>3</sup>
---------------	-------------	-------	----------------------

83x56x105h cm	1 Pc/carton	24 Kg	0,275 m <sup>3</sup>
---------------	-------------	-------	----------------------



Code	Description	Color
------	-------------	-------

MX 203		Multifunctional enclosed plastic trolley
21001IDEA/MX	1 IDEA base equipped with 4 natural rubber castors Ø 100 mm without brake (item no. 21008) and door stop	●
21003 B	1 Base end	●
23002	2 Vertical frames for MX	○
23007 B	2 Central doors MX with lock (without key)	●
23011N	1 Left door for MX/DMX	○
23012N	1 Right door for MX/DMX	○
2250 B	1x6 lt bucket	●
2250 R	1x6 lt bucket	●
23005 B	1 Bag-holder equipped with 4 handle holders, lid with document holder and sliding device for MX/DMX	●
23004 B	1 Plastic upper end with 3 handle-holders for MX/DMX	●
23003/1	1 Upper tray for buckets for MX/DMX	●
23015 GR	1 Tray MX	○
KITMX/G	1 Assembling kit for MX 203-204	○

Code	Description	Color
------	-------------	-------

MX 204		Multifunctional enclosed plastic trolley
21001IDEA/MX	1 IDEA base equipped with 4 natural rubber castors Ø 100 mm without brake (item no. 21008) and door stop	●
21003 B	1 Base end	●
23002	2 Vertical frames for MX	○
23007 B	2 Central doors MX with lock (without key)	●
23011N	1 Left door for MX/DMX	○
23012N	1 Right door for MX/DMX	○
2250 B	1x6 lt bucket	●
2250 R	1x6 lt bucket	●
7030 B	1x22 lt rect. bucket	●
7038	1 Lid for 22 lt rect. bucket	●
23005 B	1 Bag-holder equipped with 4 handle holders, lid with document holder and sliding device for MX/DMX	●
23004 B	1 Plastic upper end with 3 handle-holders for MX/DMX	●
23003/1	1 Upper tray for buckets for MX/DMX	●
23015 GR	1 Tray MX	○
23046	1 Rilsan basket for 22 lt bucket for MX/DMX	○
KITMX/G	1 Assembling kit for MX 203-204	○

83x56x105h cm	1 Pc/carton	26 Kg	0,275 m <sup>3</sup>
---------------	-------------	-------	----------------------

105x56x105h cm	1 Pc/carton	29,5 Kg	0,300 m <sup>3</sup>
----------------	-------------	---------	----------------------



Code	Description	Color
<b>MX 300</b>	<b>Multifunctional enclosed plastic trolley</b>	
<b>MX 300 S/P</b>	<b>Multifunctional enclosed plastic trolley without wringer</b>	
21001IDEA/BASE	1 IDEA base equipped with 4 natural rubber castors Ø 100 mm without brake (item no. 21008)	●
21002IDEA/BASE	1 Base extension equipped with natural rubber castor Ø 100 mm without brake (item no. 21008)	●
23002	2 Vertical frames for MX	○
21005 B	1x15 lt bucket for IDEA	●
21005 R	1x15 lt bucket for IDEA	●
2250 B	1x6 lt bucket	●
2250 R	1x6 lt bucket	●
23005 B	1 Bag-holder equipped with 4 handle holders, lid with document holder and sliding device for MX/DMX	●
23004 B	1 Plastic upper end with 3 handle-holders for MX/DMX	●
23003/1	1 Upper tray for buckets for MX/DMX	●
23015 GR	1 Tray MX	○
23008	1 Plastic wringer support with coupling system for IDEA	●
4100PB	1 Plastic wringer	●
KITMX/I	1 Assembling kit for MX 300	●

Code	Description	Color
<b>MX 301</b>	<b>Multifunctional enclosed plastic trolley</b>	
<b>MX 301 S/P</b>	<b>Multifunctional enclosed plastic trolley without wringer</b>	
21001IDEA/BASE	1 IDEA base equipped with 4 natural rubber castors Ø 100 mm without brake (item no. 21008)	●
21002IDEA/BASE	1 Base extension equipped with natural rubber castor Ø 100 mm without brake (item no. 21008)	●
23002	2 Vertical frames for MX	○
23007 B	2 Central doors MX with lock (without key)	●
21005 B	1x15 lt bucket for IDEA	●
21005 R	1x15 lt bucket for IDEA	●
2250 B	1x6 lt bucket	●
2250 R	1x6 lt bucket	●
23005 B	1 Bag-holder equipped with 4 handle holders, lid with document holder and sliding device for MX/DMX	●
23004 B	1 Plastic upper end with 3 handle-holders for MX/DMX	●
23003/1	1 Upper tray for buckets for MX/DMX	●
23015 GR	1 Tray MX	○
23008	1 Plastic wringer support with coupling system for IDEA	●
4100PB	1 Plastic wringer	●
KITMX/J	1 Assembling kit for MX 301	●



<b>110x56x105h cm</b>	1 Pc/carton	<b>24,5 Kg</b>	<b>0,390 m<sup>3</sup></b>
	1 Pc/carton	<b>22 Kg</b>	<b>0,390 m<sup>3</sup></b>



<b>105x56x105h cm</b>	1 Pc/carton	<b>27,5 Kg</b>	<b>0,390 m<sup>3</sup></b>
	1 Pc/carton	<b>25 Kg</b>	<b>0,390 m<sup>3</sup></b>



Code	Description	Color
<b>MX 302</b>	<b>Multifunctional enclosed plastic trolley</b>	
<b>MX 302 S/P</b>	<b>Multifunctional enclosed plastic trolley without wringer</b>	
21001IDEA/BASE	1 IDEA base equipped with 4 natural rubber castors Ø 100 mm without brake (item no. 21008)	●
21002IDEA/MX	1 Base extension equipped with natural rubber castor Ø 100 mm without brake (item no. 21008) and with door stop	●
23002	2 Vertical frames for MX	○
23011N	1 Left door for MX/DMX	○
23012N	1 Right door for MX/DMX	○
21005 B	1x15 lt bucket for IDEA	●
21005 R	1x15 lt bucket for IDEA	●
2250 B	1x6 lt bucket	●
2250 R	1x6 lt bucket	●
23005 B	1 Bag-holder equipped with 4 handle holders, lid with document holder and sliding device for MX/DMX	●
23004 B	1 Plastic upper end with 3 handle-holders for MX/DMX	●
23003/1	1 Upper tray for buckets for MX/DMX	●
23015 GR	1 Tray MX	○
23008	1 Plastic wringer support with coupling system for IDEA	●
4100PB	1 Plastic wringer	●
KITMX/K	1 Assembling kit for MX 302	●

Code	Description	Color
<b>MX 303</b>	<b>Multifunctional enclosed plastic trolley</b>	
<b>MX 303 S/P</b>	<b>Multifunctional enclosed plastic trolley without wringer</b>	
21001IDEA/BASE	1 IDEA base equipped with 4 natural rubber castors Ø 100 mm without brake (item no. 21008)	●
21002IDEA/MX	1 Base extension equipped with natural rubber castor Ø 100 mm without brake (item no. 21008) and with door stop	●
23002	2 Vertical frames for MX	○
23007 B	2 Central doors MX with lock (without key)	●
23011N	1 Left door for MX/DMX	○
23012N	1 Right door for MX/DMX	○
21005 B	1x15 lt bucket for IDEA	●
21005 R	1x15 lt bucket for IDEA	●
2250 B	1x6 lt bucket	●
2250 R	1x6 lt bucket	●
23005 B	1 Bag-holder equipped with 4 handle holders, lid with document holder and sliding device for MX/DMX	●
23004 B	1 Plastic upper end with 3 handle-holders for MX/DMX	●
23003/1	1 Upper tray for buckets for MX/DMX	●
23015 GR	1 Tray MX	○
23008	1 Plastic wringer support with coupling system for IDEA	●
4100PB	1 Plastic wringer	●
KITMX/L	1 Assembling kit for MX 303	●

 <b>110x56x105h cm</b>	 1 Pc/carton	<b>29,5 Kg</b>	<b>0,390 m³</b>
	 1 Pc/carton	<b>27 Kg</b>	<b>0,390 m³</b>

 <b>110x56x105h cm</b>	 1 Pc/carton	<b>31,5 Kg</b>	<b>0,390 m³</b>
	 1 Pc/carton	<b>29 Kg</b>	<b>0,390 m³</b>





Code	Description	Color
------	-------------	-------

**MX 304 Multifunctional enclosed plastic trolley**



21001IDEA/BASE	1 IDEA base equipped with 4 natural rubber castors Ø 100 mm without brake (item no. 21008)	●
21002IDEA/MX	1 Base extension equipped with natural rubber castor Ø 100 mm without brake (item no. 21008) and with door stop	●
23002	2 Vertical frames for MX	○
23007 B	2 Central doors MX with lock (without key)	●
23011N	1 Left door for MX/DMX	○
23012N	1 Right door for MX/DMX	○
23020 G	1x4 lt bucket	●
23020 R	1x4 lt bucket	●
2250 B	1x6 lt bucket	●
7030 R	1x22 lt rect. bucket	●
23005 B	1 Bag-holder equipped with 4 handle holders, lid with document holder and sliding device for MX/DMX	●
23004 B	1 Plastic upper end with 3 handle-holders for MX/DMX	●
23003/1	1 Upper tray for buckets for MX/DMX	●
23015 GR	1 Tray MX	○
KITMX/M	1 Assembling kit MX 304-305-501	



Code	Description	Color
------	-------------	-------

**MX 305 Multifunctional enclosed plastic trolley**

**MX 305 S/P Multifunctional enclosed plastic trolley without wringer**

21001IDEA/BASE	1 IDEA base equipped with 4 natural rubber castors Ø 100 mm without brake (item no. 21008)	●
21002IDEA/MX	1 Base extension equipped with natural rubber castor Ø 100 mm without brake (item no. 21008) and with door stop	●
23002	2 Vertical frames for MX	○
23007 B	2 Central doors MX with lock (without key)	●
23011N	1 Left door for MX/DMX	○
23012N	1 Right door for MX/DMX	○
2250 B	1x6 lt bucket	●
2250 R	1x6 lt bucket	●
23005 B	1 Bag-holder equipped with 4 handle holders, lid with document holder and sliding device for MX/DMX	●
23004 B	1 Plastic upper end with 3 handle-holders for MX/DMX	●
23003/1	1 Upper tray for buckets for MX/DMX	●
23015 GR	1 Tray MX	○
MAC 50G+P	1 Mopping unit mono 20 lt	●
KITMX/M	1 Assembling kit MX 304-305-501	

 110x56x105h cm	 1 Pc/carton	27,4 Kg	0,390 m <sup>3</sup>
--	---	---------	----------------------



 110x56x105h cm	 1 Pc/carton	29,7 Kg	0,390 m <sup>3</sup>
	 1 Pc/carton	27,2 Kg	0,390 m <sup>3</sup>







Code	Description	Color
<b>MX 400</b>	<b>Multifunctional enclosed plastic trolley</b>	
21001IDEA/BASE	1 IDEA base equipped with 4 natural rubber castors Ø 100 mm without brake (item no. 21008)	●
21002IDEA/BASE	1 Base extension equipped with natural rubber castor Ø 100 mm without brake (item no. 21008)	●
23002	2 Vertical frames for MX	○
2250 B	1x6 lt bucket	●
2250 R	1x6 lt bucket	●
23005 B	2 Bag-holders equipped with 4 handle holders, lid with document holder and sliding device for MX/DMX	●
23003/1	1 Upper tray for buckets for MX/DMX	●
23015 GR	1 Tray MX	○
KITMX/O	1 Assembling kit for MX 400	

Code	Description	Color
<b>MX 401</b>	<b>Multifunctional enclosed plastic trolley</b>	
21001IDEA/BASE	1 IDEA base equipped with 4 natural rubber castors Ø 100 mm without brake (item no. 21008)	●
21002IDEA/BASE	1 Base extension equipped with natural rubber castor Ø 100 mm without brake (item no. 21008)	●
23002	2 Vertical frames for MX	○
23007 B	2 Central doors MX with lock (without key)	●
2250 B	1x6 lt bucket	●
2250 R	1x6 lt bucket	●
23005 B	2 Bag-holders equipped with 4 handle holders, lid with document holder and sliding device for MX/DMX	●
23003/1	1 Upper tray for buckets for MX/DMX	●
23015 GR	1 Tray MX	○
KITMX/P	1 Assembling kit for MX 401	



 **110x56x105h cm** |  **1 Pc/carton**    **21 Kg**    **0,290 m<sup>3</sup>**



 **110x56x105h cm** |  **1 Pc/carton**    **25 Kg**    **0,290 m<sup>3</sup>**



Code	Description	Color
<b>MX 402</b>	<b>Multifunctional enclosed plastic trolley</b>	
21001IDEA/MX	1 IDEA base equipped with 4 natural rubber castors Ø 100 mm without brake (item no. 21008) and door stop	●
21002IDEA/MX	1 Base extension equipped with natural rubber castor Ø 100 mm without brake (item no. 21008) and with door stop	●
23002	2 Vertical frames for MX	○
23011N	2 Left doors for MX/DMX	○
23012N	2 Right doors for MX/DMX	○
2250 B	1x6 lt bucket	●
2250 R	1x6 lt bucket	●
23005 B	2 Bag-holders equipped with 4 handle holders, lid with document holder and sliding device for MX/DMX	●
23003/1	1 Upper tray for buckets for MX/DMX	●
23015 GR	1 Tray MX	○
KITMX/Q	1 Assembling kit for MX 402	

Code	Description	Color
<b>MX 403</b>	<b>Multifunctional enclosed plastic trolley</b>	
21001IDEA/MX	1 IDEA base equipped with 4 natural rubber castors Ø 100 mm without brake (item no. 21008) and door stop	●
21002IDEA/MX	1 Base extension equipped with natural rubber castor Ø 100 mm without brake (item no. 21008) and with door stop	●
23002	2 Vertical frames for MX	○
23007 B	2 Central doors MX with lock (without key)	●
23011N	2 Left doors for MX/DMX	○
23012N	2 Right doors for MX/DMX	○
2250 B	1x6 lt bucket	●
2250 R	1x6 lt bucket	●
23005 B	2 Bag-holders equipped with 4 handle holders, lid with document holder and sliding device for MX/DMX	●
23003/1	1 Upper tray for buckets for MX/DMX	●
23015 GR	1 Tray MX	○
KITMX/R	1 Assembling kit for MX 403	

 **110x56x105h cm** |  **1 Pc/2 cartons 31 Kg 0,415 m³**

 **110x56x105h cm** |  **1 Pc/2 cartons 33Kg 0,415 m³**



Code	Description	Color
<b>MX 500</b>	<b>Multifunctional enclosed plastic trolley</b>	
21001IDEA/BASE	1 IDEA base equipped with 4 natural rubber castors Ø 100 mm without brake (item no. 21008)	●
21002IDEA/MX	1 Base extension equipped with natural rubber castor Ø 100 mm without brake (item no. 21008) and with door stop	●
23002	2 Vertical frames for MX	○
23007 B	2 Central doors MX with lock (without key)	●
23011N	1 Left door for MX/DMX	○
23012N	1 Right door for MX/DMX	○
23020 G	1x4 lt bucket	●
23020 R	1x4 lt bucket	●
2250 B	1x6 lt bucket	●
7030 B	1x22 lt rect. bucket	●
7030 R	1x22 lt rect. bucket	●
23005 B	1 Bag-holder equipped with 4 handle holders, lid with document holder and sliding device for MX/DMX	●
23004 B	1 Plastic upper end with 3 handle-holders for MX/DMX	●
23003/1	1 Upper tray for buckets for MX/DMX	●
23015 GR	1 Tray MX	○
GR23085	1 Rilsan support for 22 lt bucket for MX/DMX	
KITMX/S	1 Assembling kit for MX 500	

Code	Description	Color
<b>MX 500 AB</b>	<b>Multifunctional enclosed plastic trolley with antibacterial protection</b>	
21001AB/BASE	1 IDEA base equipped with 4 natural rubber castors Ø 100 mm without brake (item no. 21008)	●
21002IDEA/MX	1 Base extension equipped with natural rubber castor Ø 100 mm without brake (item no. 21008) and with door stop	●
23002	2 Vertical frames for MX	○
23007 B	2 Central doors MX with lock (without key)	●
23011N	1 Left door for MX/DMX	○
23012N	1 Right door for MX/DMX	○
23020 G	1x4 lt bucket	●
23020 R	1x4 lt bucket	●
2250 BA	1x6 lt bucket	●
7030 BA	1x22 lt rect. bucket	●
7030 RA	1x22 lt rect. bucket	●
23005 BA	1 Bag-holder equipped with 4 handle holders, lid with document holder and sliding device for MX/DMX	●
23004 B	1 Plastic upper end with 3 handle-holders for MX/DMX	●
23003/1	1 Upper tray for buckets for MX/DMX	●
23015 GR	1 Tray MX	○
GR23085	1 Rilsan support for 22 lt bucket for MX/DMX	
KITMX/S	1 Assembling kit for MX 500	

<b>110x56x105h cm</b>	<b>1 Pc/carton</b>	<b>31 Kg</b>	<b>0,390 m<sup>3</sup></b>
-----------------------	--------------------	--------------	----------------------------

**Optional** (shown in the picture)

7032 Folding stainless steel grid (for 22 lt rect. bucket)

<b>110x56x105h cm</b>	<b>1 Pc/carton</b>	<b>31 Kg</b>	<b>0,390 m<sup>3</sup></b>
-----------------------	--------------------	--------------	----------------------------

**Optional** (shown in the picture)

7032 Folding stainless steel grid (for 22 lt rect. bucket)



Code	Description	Color
<b>MX 501</b>	<b>Multifunctional enclosed plastic trolley</b>	
21001IDEA/BASE	1 IDEA base equipped with 4 natural rubber castors Ø 100 mm without brake (item no. 21008)	●
21002IDEA/MX	1 Base extension equipped with natural rubber castor Ø 100 mm without brake (item no. 21008) and with door stop	●
23002	2 Vertical frames for MX	○
23007 B	2 Central doors MX with lock (without key)	●
23011N	1 Left door for MX/DMX	○
23012N	1 Right door for MX/DMX	○
23020 G	1x4 lt bucket	●
23020 R	1x4 lt bucket	●
2250 B	1x6 lt bucket	●
7030 B	1x22 lt rect. bucket	●
7030 R	1x22 lt rect. bucket	●
7038	2 Lids for 22 lt rect. bucket	●
23005 B	1 Bag-holder equipped with 4 handle holders, lid with document holder and sliding device for MX/DMX	●
23004 B	1 Plastic upper end with 3 handle-holders for MX/DMX	●
23003/1	1 Upper tray for buckets for MX/DMX	●
23015 GR	1 Tray MX	○
GR23078	1 Rilsan frame bucket holder trolley	
KITMX/M	1 Assembling kit MX 304-305-501	









Code	Description	Color
<b>23078</b>	<b>22 lt bucket holder with rilsan protection for MX</b>	
GR23078	1 Rilsan frame bucket holder trolley	
7030 B	1x22 lt rect. bucket	●
7030 R	1x22 lt rect. bucket	●

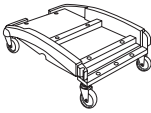
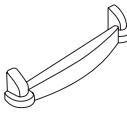
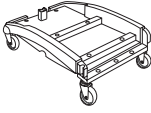
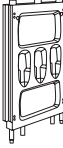
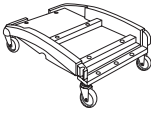
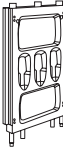
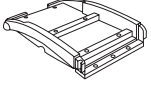

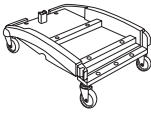
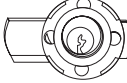
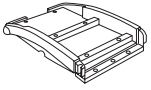

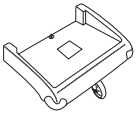

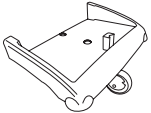

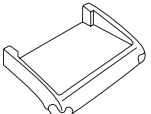
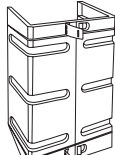

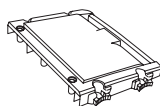

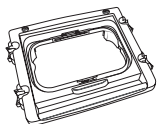
**110x56x105h cm** | **1 Pc/2 cartons 38 Kg 0,660 m³**

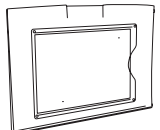
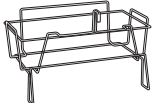
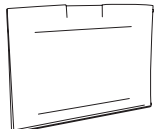
**60x38x96h cm** | **2 Pcs/carton 19 Kg 0,330 m³**

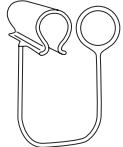

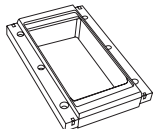
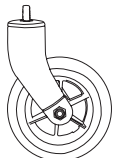
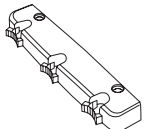
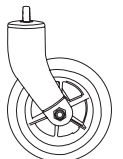



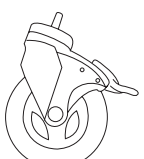



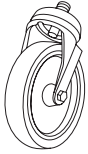

**Optional** (shown in the picture)

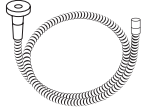

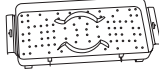
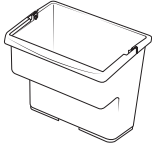
7032 Folding stainless steel grid (for 22 lt rect. bucket)

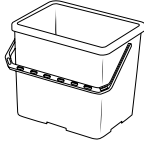
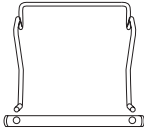
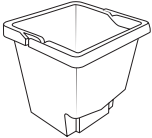
Code	Description	Color	Code	Description	Color
	21001 IDEA/BASE IDEA base equipped with 4 natural rubber castors Ø 100 mm without brake (item no. 21008)	●		21003 B Base end	●
	21001 IDEA/MX IDEA base equipped with 4 natural rubber castors Ø 100 mm without brake (item no. 21008) and door stop	●		23002 Vertical frame for MX	○
	21001 IDEA/PL IDEA base equipped with 4 castors Ø 100 mm (item no. 24060)	●		23002/100 Vertical frame for MX 100	○
	21001 B IDEA base without castors	●		23007 B Central door MX with lock (without key)	●
	21001 AB/BASE IDEA/AB base equipped with 4 natural rubber castors Ø 100 mm without brake (item no. 21008)	●		23013 Lock for MX-DMX	○
	21001 VS IDEA/AB base without castors	●		23014 Key for lock MX and DMX	○
	21002 IDEA/BASE Base extension equipped with natural rubber castor Ø 100 mm without brake (item no. 21008)	●		23011N Left door for MX/DMX	○
	21002 IDEA/MX Base extension equipped with natural rubber castor Ø 100 mm without brake (item no. 21008) and with door stop	●		23012N Right door for MX/DMX	○
	21002 B Base extension without castor	●		23010 N Complete set of doors MX/DMX	○

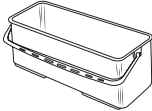
Code	Description	Color	Code	Description	Color
	23005 B Bag-holder equipped with 4 handle holders, lid with document holder and sliding device for MX/DMX	●		23024 Plastic basket for buckets with handle holder and hook for MX/DMX	●
	23005/100 B Bag-holder without lid equipped with 4 handle holders for MX/DMX	●		23025 Basket for buckets without handle holder and hook for MX 100	●
	23006 B Lid with transparent document holder for plastic bag-holder	●		23046 Rilsan basket for 22 lt bucket for MX/DMX	
	23006/N Lid without transparent document holder for plastic bag-holder	●		GR23085 Rilsan support for 22 lt bucket for MX/DMX	
	1701 Plastic clip with ring	●		21008 Natural rubber castor Ø 100 mm without brake with thread 10x15	
	23003/1 Upper tray for buckets for MX/DMX	●		21009 Natural rubber castor Ø 100 mm with brake with thread 10x15	
	23004 B Plastic upper end with 3 handle-holders for MX/DMX	●		21027 Outdoor soft castor Ø 125 mm	
	2709 Plastic device with clips for plastic bag holder	●		21028 Outdoor soft castor Ø 125 mm spec. without brake (to be used with item no. 21029 only)	
	GR23078 Rilsan frame bucket holder trolley			21029 Outdoor soft castor Ø 125 mm spec. with brake (to be used with item no. 21028 only)	

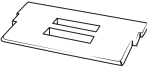
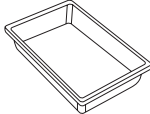

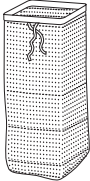
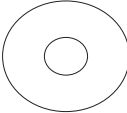
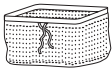
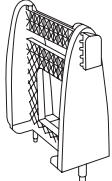
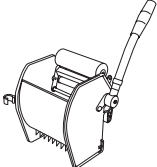
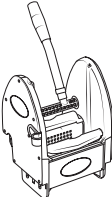
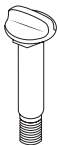
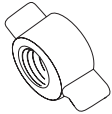
Code	Description	Color	Code	Description	Color
	24060 Castor Ø 100 mm with thread 10x15			2252 Lid for 6 lt bucket	●
	24061 Castor Ø 100 mm XL without brake with thread 10x15			7038 Lid for 22 lt rect. bucket	●
	24062 Castor Ø 100 mm XL with brake with thread 10x15			1071 FAST water hose	
	21012 Castor Ø 125 mm XL without brake with thread 10x15			7080 Tecno-Shower dispenser	●
	23020 G 23020 R 4 lt bucket	● ●		7032 Folding stainless steel grid (for 22 lt rect. bucket)	
	2250 B 2250 BA 2250 R 6 lt bucket	● ● ●		23100 Roll holder for bag holder	
	21005 B 21005 R 15 lt bucket for IDEA	● ●		KIT23030 Rubber handle holder kit	
	7030 B 7030 BA 7030 R 7030 RA 22 lt rect. bucket	● ● ● ●		4260/2 Sign panel (SLIPPERY FLOOR / WET FLOOR)	
	23021 Lid for 4 lt bucket	●		23015 GR Tray MX	○

Code	Description	Color	Code	Description	Color
	23095	Net bag 70 lt with closing string		4219	Washer 6x24
	23097	Net bag for 22 lt bucket with closing string			
	23008	Plastic wringer support with coupling system for IDEA			●
	3501 VDM	Roller wringer ELPAROLL			
	4100PB	Plastic wringer			●
	21035 B	Threaded pin			●
	21036	Threaded ring nut			●
	21030 B	Plug for base			●
	1648	Plastic wing screw 6x15			



# Multifunctional Open Plastic Trolleys

---

Ideabase	94
----------	----

---

Ideabase PL	103
-------------	-----

---

Ideaplus	106
----------	-----

# Multifunctional Open Plastic Trolleys



**Compact.** IDEAPLUS, with its reduced dimensions, is equipped with extractable bag holder, hold by three fixing plates.



**Modular.** By using the ELPAROLL roller wringer (item no. 3501 VDM) it is possible to work adding an extra 12 lt bucket, thus separating the clean and dirty water



**Accessories.** It is possible to add a duo bag holder – capacity 120 lt each bag.



**Ergonomic.** The arch base gives stability to the trolley over the time and in overloading conditions, thus granting a better maneuverability and less effort for the operator.



**Everything at hand.** Multifunction device: handle holder, broom holder, sign panel holder.

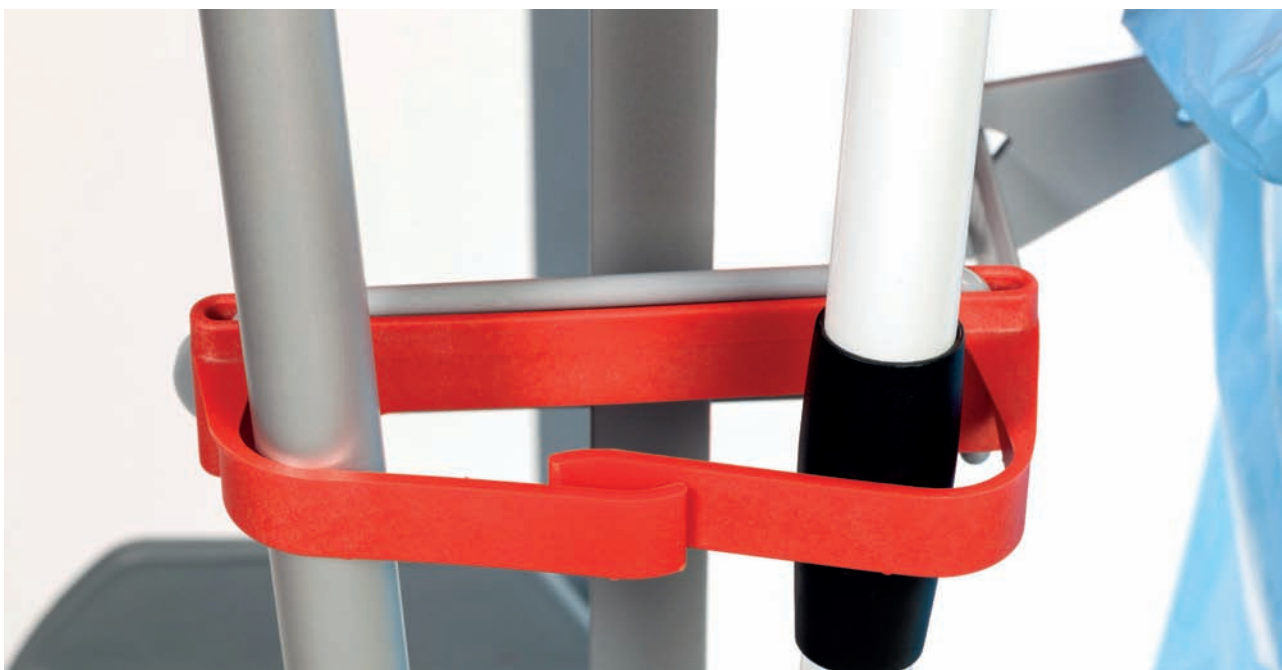





Code	Description	Color
------	-------------	-------

**IDEABASE 1 Multifunctional open plastic trolley**

21001IDEA/BASE	1 IDEA base equipped with 4 natural rubber castors Ø 100 mm without brake (item no. 21008)	●
21003 B	1 Base end	●
GR21016	1 Rilsan vertical frame with bag holder and rubber ring for IDEABASE	●
2250 B	1x6 lt bucket	●
2250 R	1x6 lt bucket	●
1666/R	1 Basket in rilsan for EUROPE/IDEABASE	●
1535/R	1 Rilsan basket for buckets for EUROPE/IDEABASE	●
8311/R	1 Small handle holder	●
KITIDEABASE/A	1 Assembling kit with 1 rubber handle holder (item no. 2255)	●

Code	Description	Color
------	-------------	-------

**IDEABASE 2 Two bag trolley IDEABASE**

21001IDEA/BASE	1 IDEA base equipped with 4 natural rubber castors Ø 100 mm without brake (item no. 21008)	●
21003 B	1 Base end	●
GR21016	1 Rilsan vertical frame with bag holder and rubber ring for IDEABASE	●
GR5013/R	1 Rilsan bag holder 120 lt equipped with clips and cover holder (item no. 7031) for BIO-R	●
KITIDEABASE/A	1 Assembling kit with 1 rubber handle holder (item no. 2255)	●

83x52x105h cm	1 Pc/carton	14,3 Kg	0,225 m <sup>3</sup>
---------------	-------------	---------	----------------------

**Optional** (shown in the picture)

7031	Rectangular lid	●
------	-----------------	---

83x52x105h cm	1 Pc/carton	12,7 Kg	0,225 m <sup>3</sup>
---------------	-------------	---------	----------------------

**Optional** (shown in the picture)

7031	Rectangular lid	●
------	-----------------	---



Code	Description	Color
------	-------------	-------

**IDEABASE 3 Three bag trolley IDEABASE**

21001IDEA/BASE	1 IDEA base equipped with 4 natural rubber castors Ø 100 mm without brake (item no. 21008)	●
21003 B	1 Base end	●
GR21015	1 Rilsan vertical frame for IDEABASE	
GR5013/R	1 Rilsan bag holder 120 lt equipped with clips and cover holder (item no. 7031) for BIO-R	
GR5027/R	1 Bag holder DUOx70 lt in rilsan with clips for BIO-R	
KITIDEABASE/A	1 Assembling kit with 1 rubber handle holder (item no. 2255)	

Code	Description	Color
------	-------------	-------

**IDEABASE 4 Multifunctional open plastic trolley**

21001IDEA/BASE	1 IDEA base equipped with 4 natural rubber castors Ø 100 mm without brake (item no. 21008)	●
21003 B	1 Base end	●
GR21016	1 Rilsan vertical frame with bag holder and rubber ring for IDEABASE	
2250 B	1x6 lt bucket	●
2250 R	1x6 lt bucket	●
7030 R	1x22 lt rect. bucket	●
1666/R	1 Basket in rilsan for EUROPE/IDEABASE	●
1535/R	1 Rilsan basket for buckets for EUROPE/IDEABASE	
8311/R	1 Small handle holder	●
KITIDEABASE/A	1 Assembling kit with 1 rubber handle holder (item no. 2255)	

83x52x105h cm	1 Pc/carton	12,6 Kg	0,225 m <sup>3</sup>
---------------	-------------	---------	----------------------

83x52x105h cm	1 Pc/carton	15,4 Kg	0,225 m <sup>3</sup>
---------------	-------------	---------	----------------------

**Optional** (shown in the picture)

7031	Rectangular lid	●
------	-----------------	---



Code	Description	Color
------	-------------	-------

**IDEABASE 5 Multifunctional open plastic trolley**

**IDEABASE 5 S/P Multifunctional open plastic trolley without wringer**

21001IDEA/BASE	IDEA base equipped with 4 natural rubber castors Ø 100 mm without brake (item no. 21008)	●
21003 B	1 Base end	●
GR21024	1 Bent vertical frame in rilsan with bag holder and rubber ring for IDEABASE	●
2250 B	1x6 lt bucket	●
2250 R	1x6 lt bucket	●
1005 R	1x25 lt bucket	●
1666/R	1 Basket in rilsan for EUROPE/IDEABASE	●
1535/R	1 Rilsan basket for buckets for EUROPE/IDEABASE	●
GR21020	1 Rilsan wringer support for IDEABASE	●
4100PR	1 Plastic wringer	●
KITIDEABASE/B	1 Assembling kit with 2 rubber handle holders (item no. 2255)	●

Code	Description	Color
------	-------------	-------

**IDEABASE 6 Multifunctional open plastic trolley**

**IDEABASE 6 S/P Multifunctional open plastic trolley without wringer**

21001IDEA/BASE	IDEA base equipped with 4 natural rubber castors Ø 100 mm without brake (item no. 21008)	●
21003 B	1 Base end	●
GR21024	1 Bent vertical frame in rilsan with bag holder and rubber ring for IDEABASE	●
2250 B	1x6 lt bucket	●
2250 R	1x6 lt bucket	●
21005 B	1x25 lt bucket	●
21005 R	1x25 lt bucket	●
1666/R	1 Basket in rilsan for EUROPE/IDEABASE	●
1535/R	1 Rilsan basket for buckets for EUROPE/IDEABASE	●
GR21020	1 Rilsan wringer support for IDEABASE	●
4100PR	1 Plastic wringer	●
KITIDEABASE/B	1 Assembling kit with 2 rubber handle holders (item no. 2255)	●

95x52x105h cm	1 Pc/carton	20,4 Kg	0,250 m <sup>3</sup>
	1 Pc/carton	18 Kg	0,250 m <sup>3</sup>

95x52x105h cm	1 Pc/carton	21 Kg	0,250 m <sup>3</sup>
	1 Pc/carton	19,4 Kg	0,250 m <sup>3</sup>



Code	Description	Color
------	-------------	-------

**IDEABASE 7 Multifunctional open plastic trolley**

21001IDEA/BASE	IDEA base equipped with 4 natural rubber castors Ø 100 mm without brake (item no. 21008)	●
21003 B	1 Base end	●
GR21016	1 Rilsan vertical frame with bag holder and rubber ring for IDEABASE	●
2250 B	1x6 lt bucket	●
2250 R	1x6 lt bucket	●
COMFORT R	1x15 lt COMFORT bucket with wringing sieve	●
1666/R	1 Basket in rilsan for EUROPE/IDEABASE	●
1535/R	1 Rilsan basket for buckets for EUROPE/IDEABASE	●
8311/R	1 Small handle holder	●
KITIDEABASE/A	1 Assembling kit with 1 rubber handle holder (item no. 2255)	●

Code	Description	Color
------	-------------	-------

**IDEABASE 8 Multifunctional open plastic trolley**

21001IDEA/BASE	IDEA base equipped with 4 natural rubber castors Ø 100 mm without brake (item no. 21008)	●
21003 B	1 Base end	●
GR21015	1 Rilsan vertical frame for IDEABASE	●
GR21016	1 Rilsan vertical frame with bag holder and rubber ring for IDEABASE	●
2250 B	1x6 lt bucket	●
2250 R	1x6 lt bucket	●
21010 B	1 Tray for IDEA	●
21010 R	1 Tray for IDEA	●
KITIDEABASE/D	1 Assembling kit with 2 rubber handle holders (item no. 2255)	●

83x52x105h cm	1 Pc/carton	15 Kg	0,225 m <sup>3</sup>
---------------	-------------	-------	----------------------

83x52x105h cm	1 Pc/carton	15,5 Kg	0,225 m <sup>3</sup>
---------------	-------------	---------	----------------------

**Optional** (shown in the picture)

7031	Rectangular lid	●
------	-----------------	---



Code	Description	Color
------	-------------	-------



**IDEABASE 9 Multifunctional open plastic trolley**

21001IDEA/BASE	1 IDEA base equipped with 4 natural rubber castors Ø 100 mm without brake (item no. 21008)	●
21003 B	1 Base end	●
GR21015	1 Rilsan vertical frame for IDEABASE	
GR21016	1 Rilsan vertical frame with bag holder and rubber ring for IDEABASE	
2250 B	1x6 lt bucket	●
2250 R	1x6 lt bucket	●
1666/R	2 Baskets in rilsan for EUROPE/IDEABASE	●
21010 B	1 Tray for IDEA	●
21010 R	1 Tray for IDEA	●
KITIDEABASE/D	1 Assembling kit with 2 rubber handle holders (item no. 2255)	●

Code	Description	Color
------	-------------	-------



**IDEABASE 10 Multifunctional open plastic trolley**

21001IDEA/BASE	1 IDEA base equipped with 4 natural rubber castors Ø 100 mm without brake (item no. 21008)	●
21002IDEA/BASE	1 Base extension equipped with natural rubber castor Ø 100 mm without brake (item no. 21008)	●
GR21015	1 Rilsan vertical frame for IDEABASE	
GR21016	1 Rilsan vertical frame with bag holder and rubber ring for IDEABASE	
2250 B	1x6 lt bucket	●
2250 R	1x6 lt bucket	●
21010 B	1 Tray for IDEA	●
21010 R	1 Tray for IDEA	●
KITIDEABASE/D	1 Assembling kit with 2 rubber handle holders (item no. 2255)	●

 83x52x105h cm	 1 Pc/carton	16,8 Kg	0,225 m <sup>3</sup>
---	---	---------	----------------------

Optional (shown in the picture)

7031	Rectangular lid	●
------	-----------------	---

 110x52x105h cm	 1 Pc/carton	17 Kg	0,225 m <sup>3</sup>
--	---	-------	----------------------



Code	Description	Color
------	-------------	-------

**IDEABASE 11 Multifunctional open plastic trolley**

21001IDEA/BASE	1 IDEA base equipped with 4 natural rubber castors Ø 100 mm without brake (item no. 21008)	●
21002IDEA/BASE	1 Base extension equipped with natural rubber castor Ø 100 mm without brake (item no. 21008)	●
GR21015	1 Rilsan vertical frame for IDEABASE	●
GR21016	1 Rilsan vertical frame with bag holder and rubber ring for IDEABASE	●
2250 B	1x6 lt bucket	●
2250 R	1x6 lt bucket	●
7030 R	1x22 lt rect. bucket	●
21010 B	1 Tray for IDEA	●
21010 R	1 Tray for IDEA	●
KITIDEABASE/D	1 Assembling kit with 2 rubber handle holders (item no. 2255)	●

Code	Description	Color
------	-------------	-------

**IDEABASE 11 FR Multifunctional open plastic trolley**

21001IDEA/BASE	1 IDEA base equipped with 4 natural rubber castors Ø 100 mm without brake (item no. 21008)	●
21002IDEA/BASE	1 Base extension equipped with natural rubber castor Ø 100 mm without brake (item no. 21008)	●
GR21015/PRE	1 Vertical frame with rilsan support for 22 lt bucket for IDEABASE	●
GR21016	1 Rilsan vertical frame with bag holder and rubber ring for IDEABASE	●
2250 B	1x6 lt bucket	●
2250 R	1x6 lt bucket	●
7030 B	1x22 lt rect. bucket	●
7030 R	1x22 lt rect. bucket	●
21010 B	1 Tray for IDEA	●
21010 R	1 Tray for IDEA	●
KITIDEABASE/D	1 Assembling kit with 2 rubber handle holders (item no. 2255)	●

110x52x105h cm	1 Pc/carton	18,4 Kg	0,225 m <sup>3</sup>
----------------	-------------	---------	----------------------

110x52x105h cm	1 Pc/carton	22 Kg	0,225 m <sup>3</sup>
----------------	-------------	-------	----------------------

**Optional (shown in the picture)**

7031	Rectangular lid	●
7032	Folding stainless steel grid (for 22 lt rect. bucket)	●





Code	Description	Color
------	-------------	-------

**IDEABASE 12 Multifunctional open plastic trolley**

**IDEABASE 12 S/P Multifunctional open plastic trolley without wringer**



21001IDEA/BASE	1 IDEA base equipped with 4 natural rubber castors Ø 100 mm without brake (item no. 21008)	●
21002IDEA/BASE	1 Base extension equipped with natural rubber castor Ø 100 mm without brake (item no. 21008)	●
GR21015	1 Rilsan vertical frame for IDEABASE	●
GR21016	1 Rilsan vertical frame with bag holder and rubber ring for IDEABASE	●
2250 B	1x6 lt bucket	●
2250 R	1x6 lt bucket	●
MAC 50R+P	1 Mopping unit mono 20 lt	●
21010 B	1 Tray for IDEA	●
21010 R	1 Tray for IDEA	●
KITIDEABASE/D	1 Assembling kit with 2 rubber handle holders (item no. 2255)	●



Code	Description	Color
------	-------------	-------

**IDEABASE 13 Multifunctional open plastic trolley**

**IDEABASE 13 S/P Multifunctional open plastic trolley without wringer**

21001IDEA/BASE	1 IDEA base equipped with 4 natural rubber castors Ø 100 mm without brake (item no. 21008)	●
21002IDEA/BASE	1 Base extension equipped with natural rubber castor Ø 100 mm without brake (item no. 21008)	●
GR21015	1 Rilsan vertical frame for IDEABASE	●
GR21016	1 Rilsan vertical frame with bag holder and rubber ring for IDEABASE	●
2250 B	1x6 lt bucket	●
2250 R	1x6 lt bucket	●
21005 B	1x15 lt bucket for IDEA	●
21005 R	1x15 lt bucket for IDEA	●
21010 B	1 Tray for IDEA	●
21010 R	1 Tray for IDEA	●
GR21020	1 Rilsan wringer support for IDEABASE	●
4100PR	1 Plastic wringer	●
KITIDEABASE/E	1 Assembling kit with 3 rubber handle holders (item no. 2255)	●

 110x52x105h cm	 1 Pc/carton	22,4 Kg	0,250 m <sup>3</sup>
	 1 Pc/carton	20 Kg	0,250 m <sup>3</sup>

 110x52x105h cm	 1 Pc/carton	22 Kg	0,250 m <sup>3</sup>
	 1 Pc/carton	19,7 Kg	0,250 m <sup>3</sup>

**Optional** (shown in the picture)

7031 Rectangular lid ●



Code	Description	Color
------	-------------	-------

**IDEABASE 16 Multifunctional open plastic trolley**

**IDEABASE 16 S/P Multifunctional open plastic trolley without wringer**

80025IDEA/BASE	1 Maxi base IDEA equipped with 2 castors with brake (item no. 80061) and 2 castors without brake (item no. 80060) Ø 125 mm	●
80043IDEA/BASE	1 Maxi base extension with 1 castor Ø 125 mm without brake (item no. 80060)	●
21003 B	1 Base end	●
GR21015	1 Rilsan vertical frame for IDEABASE	
GR21016	1 Rilsan vertical frame with bag holder and rubber ring for IDEABASE	
2250 B	1x6 lt bucket	●
2250 G	1x6 lt bucket	●
2250 R	1x6 lt bucket	●
2250 VS	1x6 lt bucket	●
21005 B	1x15 lt bucket for IDEA	●
21005 R	1x15 lt bucket for IDEA	●
2253	1 Bottles divider for 6 lt bucket	●
21070 B	1 Maxi tray with 4 broom holders for IDEA	●
21070 R	1 Maxi tray with 4 broom holders for IDEA	●
24058	1 Plastic wringer support for IDEA	●
4100PR	1 Plastic wringer	●
KITIDEABASE/H	1 Assembling kit with 2 hooks without junction (item no. 2231/G) and 2 handle holders without coupling (item no. 2230/P)	●

Code	Description	Color
------	-------------	-------

**IDEABASE 17 Multifunctional open plastic trolley**

80025IDEA/BASE	1 Maxi base IDEA equipped with 2 castors with brake (item no. 80061) and 2 castors without brake (item no. 80060) Ø 125 mm	●
80043IDEA/BASE	1 Maxi base extension with 1 castor Ø 125 mm without brake (item no. 80060)	●
21003 B	1 Base end	●
GR21015/PRE	1 Vertical frame with rilsan support for 22 lt bucket for IDEABASE	
GR21016	1 Rilsan vertical frame with bag holder and rubber ring for IDEABASE	
2250 B	1x6 lt bucket	●
2250 G	1x6 lt bucket	●
2250 R	1x6 lt bucket	●
2250 VS	1x6 lt bucket	●
7030 B	1x22 lt rect. bucket	●
7030 R	1x22 lt rect. bucket	●
2253	1 Bottles divider for 6 lt bucket	●
21070 B	1 Maxi tray with 4 broom holders for IDEA	●
21070 R	1 Maxi tray with 4 broom holders for IDEA	●
KITIDEABASE/I	1 Assembling kit with 2 hooks without junction (item no. 2231/G) and 2 handle holders without coupling (item no. 2230/P)	●

135x61x113h cm	1 Pc/carton	28,5 Kg	0,390 m <sup>3</sup>
	1 Pc/carton	26 Kg	0,390 m <sup>3</sup>

135x61x113h cm	1 Pc/carton	26 Kg	0,390 m <sup>3</sup>
----------------	-------------	-------	----------------------

**Optional (shown in the picture)**

7032	Folding stainless steel grid (for 22 lt rect. bucket)
------	---



Code	Description	Color
------	-------------	-------

**IDEABASE 18 Multifunctional open plastic trolley**

80025IDEA/BASE	1 Maxi base IDEA equipped with 2 castors with brake (item no. 80061) and 2 castors without brake (item no. 80060) Ø 125 mm	●
21003 B	2 Base ends	●
2250 B	1x6 lt bucket	●
2250 R	1x6 lt bucket	●
24053	1 Basket for IDEA	●
24051	1 Basket for buckets for IDEA	●
21068	1 Bag holder DUOx120 lt in rilsan with small rubber ring without lids for IDEABASE	●
GR21015/DUO	1 Rilsan vertical frame with fixing plates for bag holder DUO	●
GR21015	1 Rilsan vertical frame for IDEABASE	●
21070 B	1 Maxi tray with 4 broom holders for IDEA	●
21070 R	1 Maxi tray with 4 broom holders for IDEA	●
KITIDEABASE/I	1 Assembling kit with 2 hooks without junction (item no. 2231/G) and 2 handle holders without coupling (item no. 2230/P)	●



Code	Description	Color
------	-------------	-------

**IDEABASE 20 Multifunctional open plastic trolley**

21001IDEA/PL	1 IDEA base equipped with 4 castors Ø 100 mm (item no. 24060)	●
21003 B	1 Base end	●
GR21024	1 Bent vertical frame in rilsan with bag holder and rubber ring for IDEABASE	●
23020 G	1x4 lt bucket	●
23020 R	1x4 lt bucket	●
7030 B	1x22 lt rect. bucket	●
7030 R	1x22 lt rect. bucket	●
24053	1 Basket for IDEA	●
24051	1 Basket for buckets for IDEA	●
GR23085	1 Rilsan support kit for 22 lt bucket for MX/DMX	●
KITIDEABASE/D	1 Assembling kit with 2 rubber handle holders (item no. 2255)	●

120x60x116h cm	1 Pc/carton	22,5 Kg	0,250 m <sup>3</sup>
----------------	-------------	---------	----------------------

95x52x105h cm	1 Pc/carton	20 Kg	0,250 m <sup>3</sup>
---------------	-------------	-------	----------------------



Code	Description	Color
------	-------------	-------

**IDEABASE 1 PL Multifunctional open plastic trolley**

21001IDEA/PL	1 IDEA base equipped with 4 castors Ø 100 mm (item no. 24060)	●
21003 B	1 Base end	●
GR21016	1 Rilsan vertical frame with bag holder and rubber ring for IDEABASE	●
2250 B	1x6 lt bucket	●
2250 R	1x6 lt bucket	●
24053	1 Basket for IDEA	●
24051	1 Basket for buckets for IDEA	●
KITIDEABASE/A	1 Assembling kit with 1 rubber handle holder (item no. 2255)	●

Code	Description	Color
------	-------------	-------

**IDEABASE 4 PL Multifunctional open plastic trolley**

21001IDEA/PL	1 IDEA base equipped with 4 castors Ø 100 mm (item no. 24060)	●
21003 B	1 Base end	●
GR21016	1 Rilsan vertical frame with bag holder and rubber ring for IDEABASE	●
2250 B	1x6 lt bucket	●
2250 R	1x6 lt bucket	●
7030 R	1x22 lt rect. bucket	●
24053	1 Basket for IDEA	●
24051	1 Basket for buckets for IDEA	●
KITIDEABASE/A	1 Assembling kit with 1 rubber handle holder (item no. 2255)	●

83x52x105h cm	1 Pc/carton	14 Kg	0,225 m <sup>3</sup>
---------------	-------------	-------	----------------------

83x52x105h cm	1 Pc/carton	15 Kg	0,225 m <sup>3</sup>
---------------	-------------	-------	----------------------



Code	Description	Color
------	-------------	-------

**IDEABASE 6 PL Multifunctional open plastic trolley**

**IDEABASE 6 PL Multifunctional open plastic trolley S/P without wringer**

21001IDEA/PL	1 IDEA base equipped with 4 castors Ø 100 mm (item no. 24060)	●
21003 B	1 Base end	●
GR24055	1 Bent vertical frame with bag holder and rubber ring for IDEABASE PL	●
2250 B	1x6 lt bucket	●
2250 R	1x6 lt bucket	●
21005 B	1x15 lt bucket for IDEA	●
21005 R	1x15 lt bucket for IDEA	●
24053	1 Basket for IDEA	●
24051	1 Basket for buckets for IDEA	●
24058	1 Plastic wringer support for IDEA	●
4100PR	1 Plastic wringer	●
KITIDEABASE/C	1 Assembling kit with 2 rubber handle holders (item no. 2255)	●

Code	Description	Color
------	-------------	-------

**IDEABASE 7 PL Multifunctional open plastic trolley**

21001IDEA/PL	1 IDEA base equipped with 4 castors Ø 100 mm (item no. 24060)	●
21003 B	1 Base end	●
GR21016	1 Rilsan vertical frame with bag holder and rubber ring for IDEABASE	●
2250 B	1x6 lt bucket	●
2250 R	1x6 lt bucket	●
24053	1 Basket for IDEA	●
24051	1 Basket for buckets for IDEA	●
COMFORT R	1x15 lt COMFORT bucket with wringing sieve	●
KITIDEABASE/A	1 Assembling kit with 1 rubber handle holder (item no. 2255)	●

95x52x105h cm	1 Pc/carton	17 Kg	0,250 m <sup>3</sup>
	1 Pc/carton	15 Kg	0,250 m <sup>3</sup>

83x52x105h cm	1 Pc/carton	14 Kg	0,225 m <sup>3</sup>
---------------	-------------	-------	----------------------





Code	Description	Color
------	-------------	-------

**IDEABASE 9 PL Multifunctional open plastic trolley**

21001IDEA/PL	1 IDEA base equipped with 4 castors Ø 100 mm (item no. 24060)	●
21003 B	1 Base end	●
GR21015	1 Rilsan vertical frame for IDEABASE	
GR21016	1 Rilsan vertical frame with bag holder and rubber ring for IDEABASE	
2250 B	1x6 lt bucket	●
2250 R	1x6 lt bucket	●
24053	2 Baskets for IDEA	●
21010 B	1 Tray for IDEA	●
21010 R	1 Tray for IDEA	●
KITIDEABASE/D	1 Assembling kit with 2 rubber handle holders (item no. 2255)	●

Code	Description	Color
------	-------------	-------

**IDEABASE 13 PL Multifunctional open plastic trolley**

Code	Description	Color
21001IDEA/PL	1 IDEA base equipped with 4 castors Ø 100 mm (item no. 24060)	●
21002IDEA/PL	1 IDEA base extension with castor Ø 100 mm (item no. 24060)	●
GR21015	1 Rilsan vertical frame for IDEABASE	
GR21016	1 Rilsan vertical frame with bag holder and rubber ring for IDEABASE	
2250 B	1x6 lt bucket	●
2250 R	1x6 lt bucket	●
21005 B	1x15 lt bucket for IDEA	●
21005 R	1x15 lt bucket for IDEA	●
24058	1 Plastic wringer support for IDEA	●
4100PR	1 Plastic wringer	●
21010 B	1 Tray for IDEA	●
21010 R	1 Tray for IDEA	●
KITIDEABASE/F	1 Assembling kit with 3 rubber handle holders (item no. 2255)	●

83x52x105h cm	1 Pc/carton	16,3 Kg	0,225 m <sup>3</sup>
---------------	-------------	---------	----------------------

110x52x105h cm	1 Pc/carton	22 Kg	0,250 m <sup>3</sup>
	1 Pc/carton	19,5 Kg	0,250 m <sup>3</sup>





Code	Description	Color
------	-------------	-------

**IDEAPLUS 15** Multifunctional open plastic trolley

**IDEAPLUS 15 S/P** Multifunctional open plastic trolley without wringer

GR20070	1 Rilsan vertical frame with screw for IDEAPLUS	●
GR8204/R	1 Rilsan bag holder 70 lt with clips for BIO-R	●
8311/R	1 Small handle holder	●
20060	1 Side basket	●
2250 B	1x6 lt bucket	●
2250 R	1x6 lt bucket	●
1205 R	1x15 lt bucket	●
4100PR	1 Plastic wringer	●
2024 R	1 Tray mini	●



Code	Description	Color
------	-------------	-------

**IDEAPLUS 25** Multifunctional open plastic trolley

**IDEAPLUS 25 S/P** Multifunctional open plastic trolley without wringer

GR20070	1 Rilsan vertical frame with screw for IDEAPLUS	●
GR8204/R	1 Rilsan bag holder 70 lt with clips for BIO-R	●
8311/R	1 Small handle holder	●
20060	1 Side basket	●
2250 B	1x6 lt bucket	●
2250 R	1x6 lt bucket	●
1005 R	1x25 lt bucket	●
4100PR	1 Plastic wringer	●
2024 R	1 Tray mini	●

 70x54x125h cm	 1 Pc/carton	15,4 Kg	0,240 m <sup>3</sup>
	 1 Pc/carton	13,4 Kg	0,240 m <sup>3</sup>

 70x54x125h cm	 1 Pc/carton	15,4 Kg	0,240 m <sup>3</sup>
	 1 Pc/carton	13,4 Kg	0,240 m <sup>3</sup>



Code	Description	Color
------	-------------	-------

**IDEAPLUS 2x15 Multifunctional open plastic trolley**

**IDEAPLUS 2x15 Multifunctional open plastic trolley without wringer**

- GR20070 1 Rilsan vertical frame with screw for IDEAPLUS
- GR8204/R 1 Rilsan bag holder 70 lt with clips for BIO-R
- 8311/R 1 Small handle holder
- 20060 1 Side basket
- 2250 B 1x6 lt bucket
- 2250 R 1x6 lt bucket
- 1205 B 1x15 lt bucket
- 1205 R 1x15 lt bucket
- 4100PR 1 Plastic wringer
- 2024 R 1 Tray mini

- 
- 
- 
- 
- 
- 
- 
- 
- 
- 

Code	Description	Color
------	-------------	-------

**IDEAPLUS 2x10+E Multifunctional open plastic trolley**







**IDEAPLUS 2x10 S/P Multifunctional open plastic trolley without wringer**



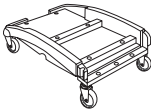
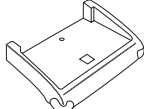
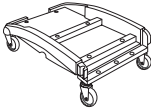
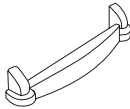
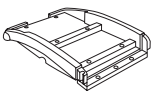

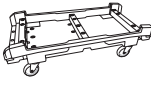
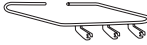
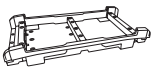
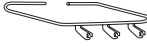
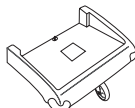

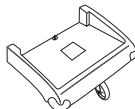
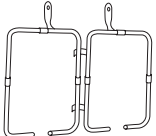
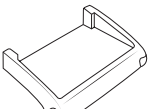
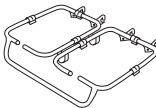
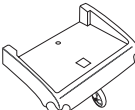



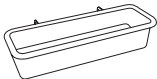

- GR20070 1 Rilsan vertical frame with screw for IDEAPLUS
- GR8204/R 1 Rilsan bag holder 70 lt with clips for BIO-R
- 8311/R 1 Small handle holder
- 20060 1 Side basket
- 2250 B 1x6 lt bucket
- 2250 R 1x6 lt bucket
- 4635 1x8 lt bucket
- 1005 R 1x25 lt bucket
- 3501 VDM 1 Roller wringer ELPAROLL
- 2024 R 1 Tray mini

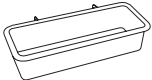
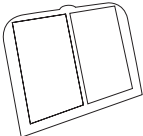
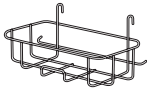



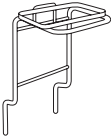

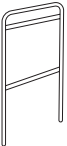
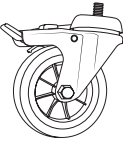



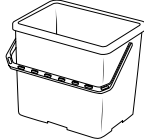

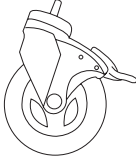

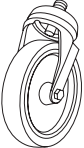
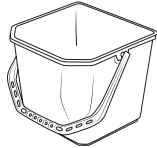

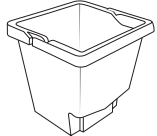

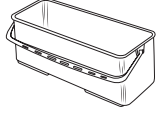

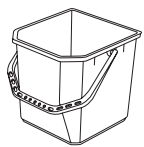
- 
- 
- 
- 
- 
- 
- 
- 
- 
- 

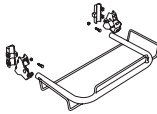

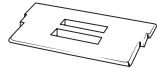

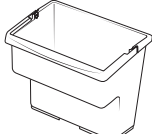







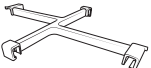

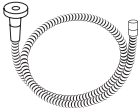
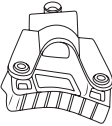
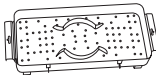
70x54x125h cm	1 Pc/carton	16,5 Kg	0,240 m <sup>3</sup>
	1 Pc/carton	14 Kg	0,240 m <sup>3</sup>

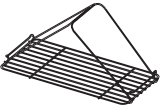
70x54x125h cm	1 Pc/carton	16,5 Kg	0,240 m <sup>3</sup>
	1 Pc/carton	14 Kg	0,240 m <sup>3</sup>

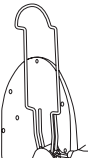

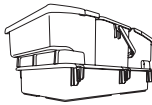
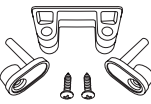

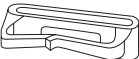
	Code	Description	Color		Code	Description	Color
	21001 IDEA/BASE	IDEA base equipped with 4 natural rubber castors $\varnothing$ 100 mm without brake (item no. 21008)	●		80043 B	Base extension without castors for maxi base	●
	21001 IDEA/PL	IDEA base equipped with 4 castors $\varnothing$ 100 mm (item no. 24060)	●		21003 B	Base end	●
	21001 B	IDEA base without castors	●		GR20070	Rilsan vertical frame with screw for IDEAPLUS	
	80025 IDEA/BASE	Maxi base IDEA equipped with 2 castors with brake (item no. 80061) and 2 castors without brake (item no. 80060) $\varnothing$ 125 mm	●		GR5013/R	Rilsan bag holder 120 lt equipped with clips and cover holder (item no. 7031) for BIO-R	
	80025 B	Maxi base without castors for IDEA	●		GR8204/R	Rilsan bag holder 70 lt with clips for BIO-R	
	21002 IDEA/BASE	Base extension equipped with natural rubber castor $\varnothing$ 100 mm without brake (item no. 21008)	●		21068	Bag holder DUOx120 lt in rilsan with small rubber ring without lids for IDEABASE	
	21002 IDEA/PL	IDEA base extension with castor $\varnothing$ 100 mm (item no. 24060)	●		GR5027/R	Bag holder DUOx70 lt in rilsan with clips for BIO-R	
	21002 B	Base extension without castor	●		21018	Bag holder DUOx70 lt IDEABASE with handle	
	80043 IDEA/BASE	Maxi base extension with castor $\varnothing$ 125 mm without brake (item no. 80061)	●		1386	Rubber ring small	

Code	Description	Color	Code	Description	Color
	1622 Rubber ring large			24053 Basket for IDEA	●
	7031 BSV Rectangular lid	●		1666/R Basket in rilsan for EUROPE/IDEABASE	
	7031 Rectangular lid	●		24051 Basket for buckets for IDEA	●
	7031AZR 7031RZR Rectangular lid with transparent document holder	● ●		1535/R Rilsan basket for buckets for EUROPE/IDEABASE	
	2710 Complete device for bag-holder (with 2 clips item no. 1701)	● ●		20060 Side basket	●
	GR21024 Bent vertical frame in rilsan with bag holder and rubber ring for IDEABASE			1038 Castor Ø 80 mm with thread 10x15	
	GR24055 Bent vertical frame with bag holder and rubber ring for IDEABASE PL			21008 Natural rubber castor Ø 100 mm without brake with thread 10x15	
	GR21015 Rilsan vertical frame for IDEABASE			21009 Natural rubber castor Ø 100 mm with brake with thread 10x15	
	GR21016 Rilsan vertical frame with bag holder and rubber ring for IDEABASE			21027 Outdoor soft castor Ø 125 mm	

Code	Description	Color	Code	Description	Color
	21028 Outdoor soft castor Ø 125 mm spec. without brake (to be used with item no. 21029 only)			2250 B 2250 G 2250 R 2250 VS 6 lt bucket	
	21029 Outdoor soft castor Ø 125 mm spec. with brake (to be used with item no. 21028 only)			4635 8 lt bucket	
	24060 Castor Ø 100 mm with thread 10x15			1205 B 1205 R 15 lt bucket	
	24061 Castor Ø 100 mm XL without brake with thread 10x15			21005 B 21005 R 15 lt bucket for IDEA	
	24062 Castor Ø 100 mm XL with brake with thread 10x15			7030 B 7030 R 22 lt rect. bucket	
	21012 Castor Ø 125 mm XL without brake with thread 10x15			1005 R 25 lt bucket	
	80060 Castor Ø 125 mm without brake for maxi base with plate			21065 KIT80040 Rilsan support for 22 lt bucket for IDEABASE Fixing kit for rilsan vertical frame (1x80040, 2x2701/R, 2x2726, 2x2730)	
	80061 Castor Ø 125 mm with brake for maxi base with plate			23021 Lid for 4 lt bucket	
	23020 B 23020 G 23020 R 23020 VS 4 lt bucket			2252 Lid for 6 lt bucket	

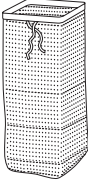
Code	Description	Color	Code	Description	Color
	7038 Lid for 22 lt rect. bucket	●		2230/P Handle holder without coupling	●
	2253 Bottles divider for 6 lt bucket	●		2231/G Hook without junction	●
	1071 FAST water hose			2255 Rubber handle holder with coupling system Ø 22 mm	
	7080 Tecno-Shower dispenser	●		21010 B 21010 R Tray for IDEA	● ●
	7032 Folding stainless steel grid (for 22 lt rect. bucket)			21070 B 21070 R Maxi tray with 4 broom holders for IDEA	● ●
	24070 Kit sign panel support			2024 R Tray mini	●
	4260/2 Sign panel (SLIPPERY FLOOR / WET FLOOR)			21011 B Tray reducer for IDEA	●
	KIT23030 Rubber handle holder kit			1677 B 1677 R Nylon bag 120 lt (72x100 cm)	● ●
	8311/R Small handle holder	●		1678 B 1678 R Nylon bag 70 lt (52x100 cm)	● ●

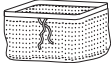
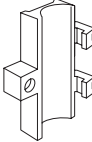
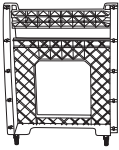
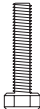
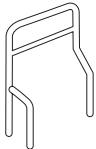
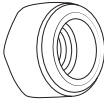
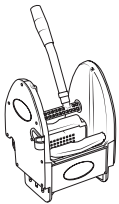

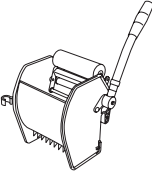
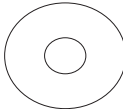
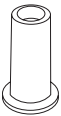
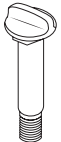
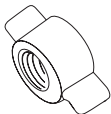
Code	Description	Color	Code	Description	Color
	23095	Net bag 70 lt with closing string		KIT80040	Fixing kit for rilsan vertical frame (1x80040, 2x2701/R, 2x2726, 2x2730)
	23097	Net bag for 22 lt bucket with closing string		2701/R	Aluminum counter plates for rilsan
	24058	Plastic wringer support for IDEA		2726	Stainless steel screw 6x25
	GR21020	Rilsan wringer support for IDEABASE		2730	Stainless steel nut 6MA
	4100PR	Plastic wringer		1648	Plastic wing screw 6x15
	3501 VDM	Roller wringer ELPAROLL		4219	Washer 6x24
	21030 B	Plug for base			
	21035 B	Threaded pin			
	21036	Threaded ring nut			





# Multifunctional Chromium Plated Trolleys

---

MINIMAX	118
L	120
HO	124
JOKER	128
H	134
EF	138

# Multifunctional Chromium Plated Trolleys

---







**Folding and compact.** Folding trolleys. Ergonomic and extraordinarily compact.















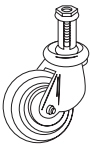

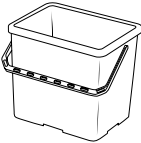

Code	Description	Color
<b>MINIMAX 2</b>	<b>Folding chromed trolley</b>	
<b>MINIMAX 2 S/P</b>	<b>Folding chromed trolley without wringer</b>	
GRMINIMAX2	1 Folding frame equipped with bag-holder with rubber ring, 2 castors Ø 80 mm (item no. 1430) with bumpers and 2 castors Ø 200 mm (item no. 1696) for MINIMAX 2	
1005 R	1x25 lt bucket	●
4100PR	1 Plastic wringer	●
2023 A	1 Tray for MINIMAX	●

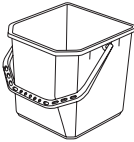

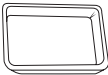
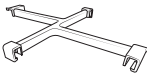
Code	Description	Color
<b>MINIMAX 3</b>	<b>Folding chromed trolley</b>	
<b>MINIMAX 3 S/P</b>	<b>Folding chromed trolley without wringer</b>	
GRMINIMAX3	1 Folding frame equipped with bag-holder with rubber ring, 4 castors Ø 80 mm (item no.1430) and bumpers for MINIMAX 3	
2250 A	1x6 lt bucket	●
2250 R	1x6 lt bucket	●
1005 R	1x25 lt bucket	●
4100PR	1 Plastic wringer	●
2023 A	1 Tray for MINIMAX	●
2024 A	1 Tray mini	●

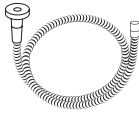
55x45x97h cm	1 Pc/carton	16,5 Kg	0,290 m <sup>3</sup>
	1 Pc/carton	14,2 Kg	0,290 m <sup>3</sup>

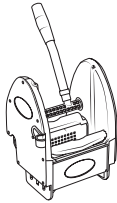
55x45x110h cm	1 Pc/carton	18,6 Kg	0,290 m <sup>3</sup>
	1 Pc/carton	16,5 Kg	0,290 m <sup>3</sup>

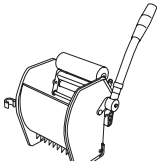
Code	Description	Color	Code	Description	Color
 GR1385	Bag holder with small rubber ring for MINIMAX		 1430	Castor Ø 80 mm with expander and thread guard	
 1386	Rubber ring small		 1031	Small bumpers	●
 1382	Threaded bar for MINIMAX 2/3		 2250 A 2250 R	6 lt bucket	● ●
 1380	Rod for MINIMAX 2/3		 1005 R	25 lt bucket	●
 GR1388	Tray support with plugs for MINIMAX		 2252	Lid for 6 lt bucket	●
 2024 A	Tray mini	●	 2253	Bottles divider for 6 lt bucket	●
 2023 A	Tray for MINIMAX	●	 1071	FAST water hose	
 1387	Drive shaft MINIMAX 2 for fix castor Ø 200 mm		 4100PR	Plastic wringer	●
 1696	Fixed castor Ø 200 mm		 3501 VDM	Roller wringer ELPAROLL	



Code	Description	Color
<b>L 1.75.80</b>	<b>Chromed multifunctional trolley "piccolo"</b>	
GR1615	1 Chrome base 75x44 cm with 4 castors Ø 80 mm (item no. 1030) and bumpers	
GR1625	1 Vertical frame with bag holder and rubber ring	
1610	1 Square lid	●
2235 A	1x12 Lt bucket	●
2235 R	1x12 Lt bucket	●
1665	1 Multifunctional basket	
1670	1 Multifunctional bucket holder	
1675	1 Broom support	
KITMULTIUSO/A	1 Assembling kit for L 1.50.80 - L 1.75.80	



Code	Description	Color
<b>LP 2.75.80</b>	<b>Chromed multifunctional trolley "plus"</b>	
<b>LP 2.75.80 S/P</b>	<b>Chromed multifunctional trolley "plus" without wringer</b>	
GR1617	1 Chrome base "plus" 75x44 with 4 castors Ø 80 mm (item no. 1030) and bumpers	
GR1625	1 Vertical frame with bag holder and rubber ring	
1610	1 Square lid	●
2235 A	1x12 Lt bucket	●
2235 R	1x12 Lt bucket	●
1666	1 Basket plus	
1675	1 Broom support	
1985	1 Wringer support 2x15 Lt	
4100PR	1 Plastic wringer	●
KITMULTIUSO/D	1 Assembling kit for LP 2.75.80	

75x44x103h cm	1 Pc/carton	13,6 Kg	0,150 m <sup>3</sup>
---------------	-------------	---------	----------------------

75x44x103h cm	1 Pc/carton	18,8 Kg	0,190 m <sup>3</sup>
	1 Pc/carton	16,5 Kg	0,150 m <sup>3</sup>



Code	Description	Color
<b>L 2.125.100</b>	<b>Chromed multifunctional trolley "maxi"</b>	
<b>L 2.125.100 S/P</b>	<b>Chromed multifunctional trolley "maxi" without wringer</b>	
GR2415/MAXI	1 Chrome base 100x44 cm with 4 castors Ø 100 mm (item no. 2030), hooks and bumpers	
GR1220	1 Frame with 4 castors Ø 80 mm (item no. 1030) and bumpers for E/EMF 2x15	
GR1625	1 Vertical frame with bag holder and rubber ring	
GR1625/TOP	1 Vertical frame without bag holder	
1610	1 Square lid	●
2225	1 Bag support	
1675	1 Broom support	
2020	2 Shelves for small tray	
1205 A	1x15 lt bucket	●
1205 R	1x15 lt bucket	●
4100PR	1 Plastic wringer	●
KITMULTIUSO/F	1 Assembling kit for L 2.125.100	

 125x44x105h cm



1 Pc/carton

26 Kg











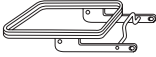
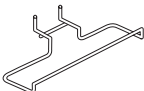
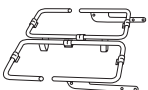

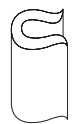
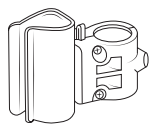

0,290 m<sup>3</sup>



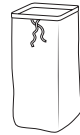

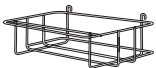

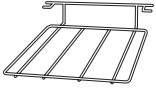

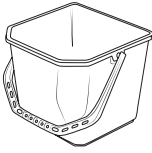

1 Pc/carton

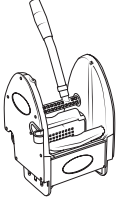
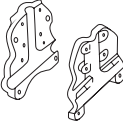
23,7 Kg

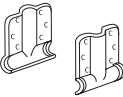
0,290 m<sup>3</sup>

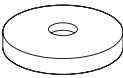
Code	Description	Color	Code	Description	Color
 GR1620	Bag holder with rubber ring		 1675	Broom support	
 1624	Bag-holder DU0x70 lt		 1640	Multifunctional threaded rod	
 1622	Rubber ring large		 1630	Multifunctional rod	
 1621	Plastic clip	●	 KIT2230	Kit handle holder Ø 22 mm with coupling system	●
 1610	Square lid	●	 1677 B 1677 R	Nylon bag 120 lt (72x100cm)	● ●
 1665	Multifunctional basket		 1678 B 1678 R	Nylon bag 70 lt (52x100cm)	● ●
 1666	Basket "plus"		 1680	Sanforized canvas bag 120 lt	
 1670	Multifunctional bucket holder		 1680/G	Sanforized canvas bag 230 lt	
 2225	Bag support		 2020	Shelf for small tray	

Code	Description	Color	Code	Description	Color
	2220 Shelf for large tray			1205 A 1205 R 15 Lt bucket	● ●
	1641 Multifunctional rod - 6x436 mm			4100PR Plastic wringer	●
	KIT1735 Kit pair fixing plates	●			
	2101 Kit PED complete				
	KIT1635 Kit metal fixing plate	●			
	1030 Castor $\varnothing$ 80 mm with thread 8x28 and thread guard				
	2030 Castor $\varnothing$ 100 mm with thread 8x28 and thread guard				
	1031 Small bumpers	●			
	2235 A 2235 R 12 Lt bucket	● ●			





















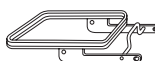

Code	Description	Color
<b>HO 8001</b>	<b>Chromed trolley HO</b>	
<b>HO 8001 S/P</b>	<b>Chromed trolley HO without wringer</b>	
GR8051	1 Base HO 8001/8002 equipped with 4 castors Ø 100 mm (item no. 2030) with thread	
4504	1 Vertical frame HO 8001 - 2 holes without bag holder	
GR4503	1 Frame HO 8001 - 5 holes with bag holder	
1675	1 Broom support	
GR8053	2 Tray holders with rods for HO	
2250 A	1x6 lt bucket	●
2250 G	1x6 lt bucket	●
2250 R	1x6 lt bucket	●
2250 VS	1x6 lt bucket	●
1205 A	1x15 lt bucket	●
1205 R	1x15 lt bucket	●
1980	1 Wringer support 2x25 lt	●
4100PR	1 Plastic wringer	●
2027 A	2 Trays medium	●
2027 R	1 Tray medium	●
KITHO/A	1 Assembling kit with 2 handle holders (item no. KIT2230)	●

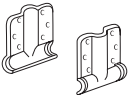

Code	Description	Color
<b>HO 8002</b>	<b>Chromed trolley HO</b>	
<b>HO 8002 S/P</b>	<b>Chromed trolley HO without wringer</b>	
GR8051	1 Base HO 8001/8002 equipped with 4 castors Ø 100 mm (item no. 2030) with thread	
GR4502	1 Frame HO 8002 - 3 holes with bag holder	
7045	1 Basket for EF/HO	
7036	1 Basket for buckets for EF/HO	
1675	1 Broom support	
2250 A	1x6 lt bucket	●
2250 R	1x6 lt bucket	●
1205 A	1x15 lt bucket	●
1205 R	1x15 lt bucket	●
1980	1 Wringer support 2x25 lt	●
4100PR	1 Plastic wringer	●
KITHO/B	1 Assembling kit with 2 handle holders (item no. KIT2230)	●

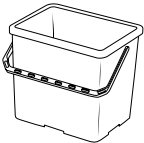
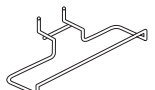
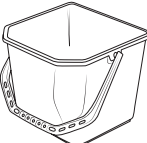
 120x50x105h cm	 1 Pc/carton	28,7 Kg	0,250 m <sup>3</sup>
	 1 Pc/carton	26,4 Kg	0,250 m <sup>3</sup>

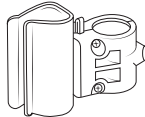
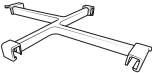
 95x50x105h cm	 1 Pc/carton	21,2 Kg	0,240 m <sup>3</sup>
	 1 Pc/carton	19 Kg	0,240 m <sup>3</sup>

Code	Description	Color	Code	Description	Color
 GR7043	Bag-holder EF/HO with rubber ring		 7042	Rod EF/HO	
 2710	Complete device for bag-holder (with 2 clips item no. 1701)	● ●	 7045	Basket for EF/HO	
 7031	Rectangular lid	●	 7036	Basket for buckets for EF/HO	
 1622	Rubber ring large		 1635	Metal fixing plate	●
 GR8055	Bag support HO with rods		 2250 A 2250 G 2250 R 2250 VS	6 lt bucket	● ● ● ●
 1675	Broom support		 1205 A 1205 R	15 lt bucket	● ●
 GR8053	Tray holder with rods for HO		 2252	Lid for 6 lt bucket	●
 KIT2230	Kit handle holder Ø 22 mm with coupling system	●	 2253	Bottles divider for 6 lt bucket	●
 7041	Threaded rod EF/HO		 2030	Castor Ø 100 mm with thread 8x28 and thread guard	

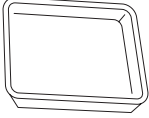
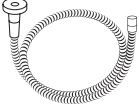
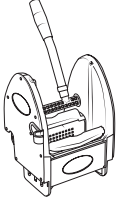
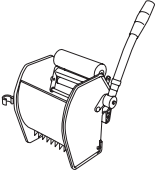
	Code	Description	Color
	1031	Small bumpers	●
	2027 A 2027 R	Tray medium	● ●
	1071	FAST water hose	
	4100PR	Plastic wringer	●
	3501 VDM	Roller wringer ELPAROLL	







Code	Description	Color
<b>JOKER 1</b>	<b>Chromed trolley JOKER</b>	
GR8201	1 Base JOKER 1-2-3 equipped with 4 castors Ø 80 mm (item no. 1430) with expander	
GR8203	1 Joker vertical frame with handle	
GR8202	1 Joker vertical frame	
GR8204	1 Bag holder 70 lt with clips for JOKER	
8311	1 Small handle holder	●
8303	1 Broom support for JOKER	
GR8205	2 Tray support mini with screw for JOKER	●
2250 A	1x6 lt bucket	●
2250 R	1x6 lt bucket	●
2024 A	2 Tray mini	●
2024 R	1 Tray mini	●
KITJOKER/A	1 Assembling kit for JOKER 1-2	●

Code	Description	Color
<b>JOKER 2</b>	<b>Chromed trolley JOKER</b>	
GR8201	1 Base JOKER 1-2-3 equipped with 4 castors Ø 80 mm (item no. 1430) with expander	
GR8202	2 Joker vertical frames	
GR8204	2 Bag holders 70 lt with clips for JOKER	
GR8206	1 Bag support 70 lt JOKER	
8311	1 Small handle holder	●
8303	1 Broom support for JOKER	
GR8205	2 Trays supports mini with screw for JOKER	●
2024 A	2 Trays mini	●
2024 R	1 Tray mini	●
KITJOKER/A	1 Assembling kit for JOKER 1-2	●

75x40x103h cm



1 Pc/carton

15 Kg

0,150 m<sup>3</sup>

100x44x103h cm



1 Pc/carton

16 Kg

0,150 m<sup>3</sup>





Code	Description	Color
------	-------------	-------

**JOKER 3 Chromed trolley JOKER**

**JOKER 3 S/P Chromed trolley JOKER without wringer**

GR8201	1 Base JOKER 1-2-3 equipped with 4 castors Ø 80 mm (item no. 1430) with expander	
GR8202	2 JOKER vertical frame	
GR8204	1 Bag holder 70 lt with clips for JOKER	
GR8206	1 Bag support 70 lt JOKER	
8311	1 Small handle holder	●
8303	1 Broom support for JOKER	●
GR8205	2 Trays supports mini with screw for JOKER	●
2250 A	1x6 lt bucket	●
2250 R	1x6 lt bucket	●
2235 A	1x12 lt bucket	●
2235 R	1x12 lt bucket	●
GR8207	1 Wringer support 2x12 lt for JOKER	●
4100PR	1 Plastic wringer	●
2024 A	2 Trays mini	●
2024 R	1 Tray mini	●
KITJOKER/B	Assembling kit for JOKER 3-4-5-6	●

Code	Description	Color
------	-------------	-------

**JOKER 4 Chromed trolley JOKER**

**JOKER 4 S/P Chromed trolley JOKER without wringer**

GR8305	1 Base JOKER 4 equipped with 4 castors Ø 100 mm (item no. 2034) with expander and bumpers	
GR8202	2 JOKER vertical frame	
GR8204	1 Bag holder 70 lt with clips for JOKER	
GR8206	1 Bag support 70 lt JOKER	
8311	1 Small handle holder	●
8303	1 Broom support for JOKER	●
GR8205	2 Trays support mini with screw for JOKER	●
2250 A	1x6 lt bucket	●
2250 R	1x6 lt bucket	●
1205 A	1x15 lt bucket	●
1205 R	1x15 lt bucket	●
GR8304	1 Wringer support 2x15 lt for JOKER	●
4100PR	1 Plastic wringer	●
2024 A	2 Trays mini	●
2024 R	1 Tray mini	●
KITJOKER/B	1 Assembling kit for JOKER 3-4-5-6	●

	1 Pc/carton	20,5 Kg	0,190 m <sup>3</sup>
	1 Pc/carton	18,2 Kg	0,190 m <sup>3</sup>

	1 Pc/carton	23,2 Kg	0,240 m <sup>3</sup>
	1 Pc/carton	21 Kg	0,240 m <sup>3</sup>







Code	Description	Color
<b>JOKER 5</b>	<b>Chromed trolley JOKER</b>	
<b>JOKER 5 S/P</b>	<b>Chromed trolley JOKER without wringer</b>	
GR8301	1 Base JOKER 5 equipped with 4 castors Ø 100 mm (item no. 2034) with expander and bumpers	
GR8202	2 JOKER vertical frames	
GR5013	1 Bag holder 120 lt with clips and cover holder (item no. 7031) for H/JOKER	
GR5014	1 Bag support 120 lt for H/JOKER	
8310	2 Large handle holders	●
GR5025	2 Small trays support with screw for H/JOKER	●
1205 A	1x15 lt bucket	●
1205 R	1x15 lt bucket	●
GR8304	1 Wringer support 2x15 lt for JOKER	●
4100PR	1 Plastic wringer	●
2025 A	2 Trays small	●
2025 R	1 Tray small	●
KITJOKER/B	1 Assembling kit with 1 handle holder (item no. KIT5018) for JOKER 3-4-5-6	●





Code	Description	Color
<b>JOKER 6</b>	<b>Chromed trolley JOKER</b>	
<b>JOKER 6 S/P</b>	<b>Chromed trolley JOKER without wringer</b>	
GR8312	1 Base JOKER 6-7 equipped with 4 castors Ø 100 mm (item no. 2034) with expander and bumpers	
GR8202	2 JOKER vertical frames	
GR5013	1 Bag holder 120 lt with clips and cover holder (item no. 7031) for H/JOKER	
GR5014	1 Bag support 120 lt for H/JOKER	
8310	1 Large handle holder	●
GR5025	2 Small trays support with screw for H/JOKER	●
1205 R	1x15 lt bucket	●
GR8304	1 Wringer support 2x15 lt for JOKER	●
4100PR	1 Plastic wringer	●
2025 A	2 Trays small	●
2025 R	1 Tray small	●
KITJOKER/B	1 Assembling kit with 1 handle holder (item no. KIT5018) for JOKER 3-4-5-6	●

 110x60x105h cm

 1 Pc/carton  
1 Pc/carton

24,5 Kg 0,250 m<sup>3</sup>  
22,2 Kg 0,250 m<sup>3</sup>

 110x45x105h cm

 1 Pc/carton  
1 Pc/carton

23,1 Kg 0,250 m<sup>3</sup>  
20,8 Kg 0,250 m<sup>3</sup>











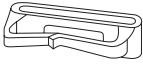
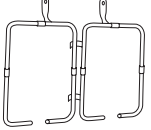
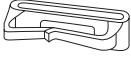

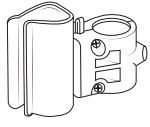
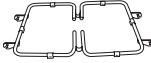

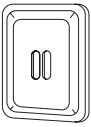
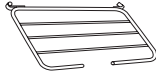



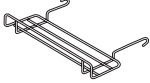
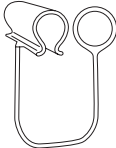

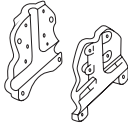
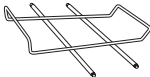
Code	Description	Color
<b>JOKER 7</b>	<b>Chromed trolley JOKER</b>	
GR8312	1 Base JOKER 6-7 equipped with 4 castors Ø 100 mm (item no. 2034) with expander and bumpers	
GR8202	2 JOKER vertical frames	
GR5013	1 Bag holder 120 lt with clips and cover holder (item no. 7031) for H/JOKER	
5017	1 Broom support H	
GR5025	2 Small trays support with screw for H/JOKER	
2025 A	2 Trays small	●
2025 R	1 Tray small	●
KITJOKER/C	1 Assembling kit with 2 handle holders (item no. KIT5018) for JOKER 7	

Code	Description	Color
<b>JOKER TRIO</b>	<b>Chromed trolley TRIO (3x120 lt)</b>	
GR8201/T	1 Base JOKER TRIO equipped with 4 castors Ø 100 mm (item no. 2034) with expander and bumpers	
GR8202	2 JOKER Vertical frames	
GR8204	1 Bag holder 70 lt with clips for JOKER	
GR8204/T	1 Double bag-holder with clips for JOKER TRIO	
GR8206	1 Bag support 70 lt JOKER	
KITJOKER/D	1 Assembling kit for JOKER TRIO	

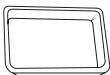
80x45x105h cm	1 Pc/carton	17 Kg	0,150 m <sup>3</sup>
---------------	-------------	-------	----------------------

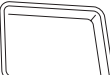
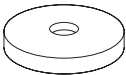
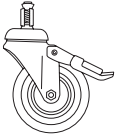
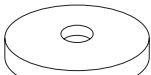
115x50x106h cm	1 Pc/carton	15,2 Kg	0,150 m <sup>3</sup>
----------------	-------------	---------	----------------------

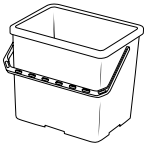
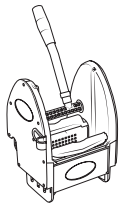
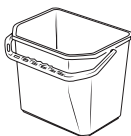
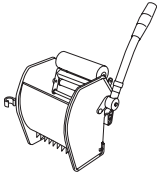
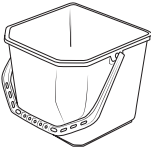
	Code	Description	Color		Code	Description	Color
	GR5013	Bag holder 120 lt with clips and cover holder (item no. 7031) for H/JOKER			8310	Large handle holder	●
	GR5027	Bag holder DUOx70 lt with clips for JOKER/H			8311	Small handle holder	●
	GR8204	Bag holder 70 lt with clips for JOKER			KIT5018	Kit handle holder Ø 20 mm with coupling system	●
	GR8204/T	Double bag-holder with clips for JOKER TRIO			GR5014	Bag support 120 lt for H/JOKER	
	5051/B 5051/R	Lid for DUO bag-holder (item no. GR5027)	● ●		GR8206	Bag support 70 lt JOKER	
	7031	Rectangular lid	●		5017	Broom support H	
	1621	Plastic clip	●		8303	Broom support for JOKER	
	1701	Plastic clip with ring	●		GR8205	Tray support mini with screw for JOKER	
	KIT1735	Kit pair fixing plates	●		GR5025	Small tray support with screw for H/JOKER	

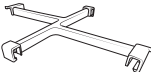
Code	Description	Color	Code	Description	Color
	2034 Castor Ø 80 mm with expander and thread guard			2024 A 2024 R Tray mini	● ●
	1430 Castor Ø 80 mm with expander and thread guard			2025 A 2025 R Tray small	● ●
	1031 Small bumpers	●		2032 Castor Ø 100 mm spec. with brake without expander	
	1036 Large bumpers	●		2033 Castor Ø 100 mm spec. without brake without expander	
	2250 A 2250 R 6 lt bucket	● ●		4100PR Plastic wringer	●
	2235 A 2235 R 12 lt bucket	● ●		3501 VDM Roller wringer ELPAROLL	
	1205 A 1205 R 15 lt bucket	● ●			
	2252 Lid for 6 lt bucket	●			
	2253 Bottles divider for 6 lt bucket	●			



Code	Description	Color
<b>H 5001</b>	<b>Chromed trolley H</b>	
<b>H 5001 S/P</b>	<b>Chromed trolley H without wringer</b>	
GR5000B	1 Large base H with 4 castors Ø 100 mm (item no. 2034) with expander and bumpers	
GR5000S	2 Vertical frames for H	
GR5013	1 Bag holder 120 lt with clips and cover holder (item no. 7031) for H/JOKER	
5010	2 Rods for H	
GR5014	1 Bag support 120 lt for H/JOKER	
5017	1 Broom support H	
GR5011	4 Round bars with screw for basket support H	
5012	2 Large baskets for H	
5024	1 Bottle divider for H	
1205 A	1x15 lt bucket	●
1205 R	1x15 lt bucket	●
GR5019	1 Wringer support with screw for H	●
4100PR	1 Plastic wringer	●
KITH	1 Assembling kit with 2 handle holders (item no. KIT5018) for H	

**While stock last**



Code	Description	Color
<b>H 5006</b>	<b>Chromed trolley H</b>	
GR5000B	1 Large base H with 4 castors Ø 100 mm (item no. 2034) with expander and bumpers	
GR5000S	2 Vertical frames for H	
GR5013	1 Bag holder 120 lt with clips and cover holder (item no. 7031) for H/JOKER	
5010	2 Rods for H	
GR5014	1 Bag support 120 lt for H/JOKER	
5017	1 Broom support H	
5023	2 Large shelves tray for H	
KITH	1 Assembling kit with 2 handle holders (item no. KIT5018) for H	

**While stock last**

110x60x105h cm	1 Pc/carton	29,2 Kg	0,290 m <sup>3</sup>
	1 Pc/carton	27 Kg	0,290 m <sup>3</sup>

110x60x105h cm	1 Pc/carton	21,7 Kg	0,150 m <sup>3</sup>
----------------	-------------	---------	----------------------



Code	Description	Color
------	-------------	-------

**H 5007**

**Chromed trolley H**

- GR5030B 1 Small base H with 4 castors Ø 100 mm (item no. 2034) with expander and bumpers
- GR5000S 2 Vertical frames for H
- 5017 1 Broom support H
- GR5025 2 Small tray supports with screw for H/JOKER
- 2025 A 2 Tray small
- 2025 R 1 Tray small
- KITH 1 Assembling kit with 2 handle holders (item no. KIT5018) for H



Code	Description	Color
------	-------------	-------

**H 5008**

**Chromed trolley H**











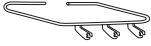

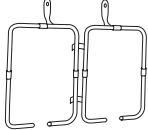

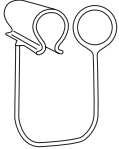
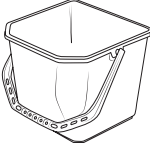

- GR5030B 1 Small base H with 4 castors Ø 100 mm (item no. 2034) with expander and bumpers
- GR5000S 2 Vertical frames for H
- GR5013 1 Bag holder 120 lt with clips and cover holder (item no. 7031) for H/JOKER
- GR5014 1 Bag support 120 lt for H/JOKER
- 5017 1 Broom support H
- GR5025 2 Small tray supports with screw for H/JOKER
- 2025 A 2 Tray small
- 2025 R 1 Tray small
- KITH 1 Assembling kit with 2 handle holders (item no. KIT5018) for H

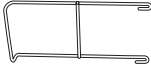

45x50x105h cm	1 Pc/carton	16,5 Kg	0,150 m <sup>3</sup>
---------------	-------------	---------	----------------------

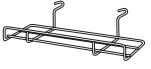
80x45x105h cm	1 Pc/carton	17,8 Kg	0,150 m <sup>3</sup>
---------------	-------------	---------	----------------------

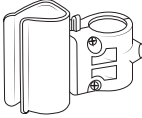

Code	Description	Color	Code	Description	Color
	GR5013 Bag holder 120 lt with clips and cover holder (item no. 7031) for H/JOKER			5023 Large shelf tray for H	
	GR5027 Bag-holder DUO 70 lt with clips for JOKER/H			GR5025 Small tray support with screw for H/JOKER	
	GR5014 Bag support 120 lt for H/JOKER			GR5011 Round bar with screw for basket support H	
	1701 Plastic clip with ring	●		1205 A 1205 R 15 lt bucket	● ●
	5051/B 5051/R Lid for DUO bag-holder (item no. GR5027)	● ●		2025 A 2025 R Tray small	● ●
	7031 Rectangular lid	●		2034 Castor Ø 80 mm with expander and thread guard	
	5024 Bottle divider for H			1031 Small bumpers	●
	5017 Broom support H			5012 Large basket for H	
	KIT5018 Kit handle holder Ø 20 mm with coupling system	●		GR5019 Wringer support with screw for H	

Code	Description	Color
------	-------------	-------

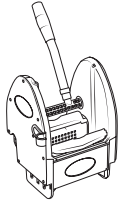

4100PR	Plastic wringer	●
--------	-----------------	---

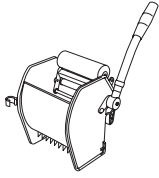

3501 VDM	Roller wringer ELPAROLL	
----------	-------------------------	--



Code	Description	Color
------	-------------	-------

**EF 7051 Chromed trolley EF**

**EF 7051 S/P Chromed trolley EF without wringer**

- GR7050 1 Large base EF with 4 castors Ø 100 mm (item no. 2034) with expander and bumpers
- GR7060/STD 1 Vertical frame without bag holder for EF
- 1675 1 Broom support
- 7040 1 Large basket for EF
- 2235 A 1x12 lt bucket
- 2235 R 1x12 lt bucket
- 7030 A 1x22 lt rect. bucket
- 7030 R 1x22 lt rect. bucket
- 7009 1 Wet flat mop EF 40x10 cm (color code)
- 4020 1 Chromed handle Ø 22 mm, 145 cm with hole (2 pieces)
- 7008 1 Stainless steel frame (40x10 cm)
- 7001 1 Stainless steel wringer
- KITEF 1 Assembling kit with 1 handle holder (item no. KIT2230) for EF



Code	Description	Color
------	-------------	-------

**EF 7052 Chromed trolley EF**

**EF 7052 S/P Chromed trolley EF without wringer**

- GR7050 1 Large base EF with 4 castors Ø 100 mm (item no. 2034) with expander and bumpers
- GR7060/STD 1 Vertical frame without bag holder for EF
- 1675 1 Broom support
- 7040 2 Large baskets for EF
- 2235 A 1x12 lt bucket
- 2235 R 1x12 lt bucket
- 7030 A 1x22 lt rect. Bucket
- 7030 R 1x22 lt rect. Bucket
- 7009 1 Wet flat mop EF 40x10 cm (color code)
- 4020 1 Chromed handle Ø 22 mm, 145 cm with hole (2 pieces)
- 7008 1 Stainless steel frame (40x10 cm)
- 7001 1 Stainless steel wringer
- 5024 1 Bottle divider for H
- KITEF 1 Assembling kit with 1 handle holder (item no. KIT2230) for EF



75x55x105h cm	1 Pc/carton	25 Kg	0,250 m <sup>3</sup>
	1 Pc/carton	18,2 Kg	0,250 m <sup>3</sup>

75x55x105h cm	1 Pc/carton	26,5 Kg	0,250 m <sup>3</sup>
	1 Pc/carton	19,7 Kg	0,250 m <sup>3</sup>



Code	Description	Color
------	-------------	-------

**EF 7053 Chromed trolley EF**

**EF 7053 S/P Chromed trolley EF without wringer**

GR7050	1 Large base EF with 4 castors Ø 100 mm (item no. 2034) with expander and bumpers	
GR7060/7053	1 Vertical frame with bag holder for EF	
1675	1 Broom support	
7040	1 Large basket for EF	
7045	1 Basket for EF/HO	
7030 A	1x22 lt rect. bucket	●
7030 R	1x22 lt rect. bucket	●
7009	1 Wet flat mop EF 40x10 cm (color code)	
4020	1 Chromed handle Ø 22 mm, 145 cm with hole (2 pieces)	
7008	1 Stainless steel frame (40x10 cm)	
7001	1 Stainless steel wringer	
KITEF	1 Assembling kit with 1 handle holder (item no. KIT2230) for EF	

Code	Description	Color
------	-------------	-------











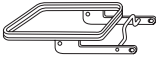
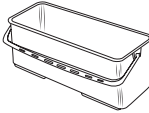

**EF 7054 Chromed trolley EF**

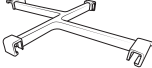
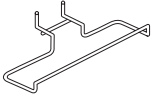
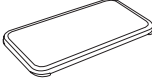

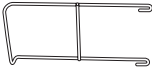
**EF 7054 S/P Chromed trolley EF without wringer**

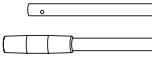
GR7051	1 Small base EF with 4 castors Ø 100 mm (item no. 2034) with expander and bumpers	
GR7060/STD	1 Vertical frame without bag holder for EF	
1675	1 Broom support	
7036	1 Basket for buckets for EF/HO	
2250 A	1x6 lt bucket	●
2250 R	1x6 lt bucket	●
7030 R	1x22 lt rect. bucket	●
7009	1 Wet flat mop EF 40x10 cm (color code)	
4020	1 Chromed handle Ø 22 mm, 145 cm with hole (2 pieces)	
7008	1 Stainless steel frame (40x10 cm)	
7001	1 Stainless steel wringer	
KITEF	1 Assembling kit with 1 handle holder (item no. KIT2230) for EF	

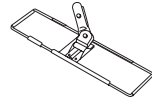
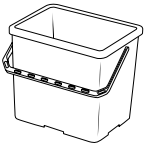
 100x55x105h cm	1 Pc/carton	26 Kg	0,250 m <sup>3</sup>
	1 Pc/carton	19,2 Kg	0,250 m <sup>3</sup>

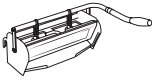
 50x55x105h cm	1 Pc/carton	21,6 Kg	0,250 m <sup>3</sup>
	1 Pc/carton	14,8 Kg	0,250 m <sup>3</sup>

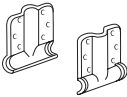
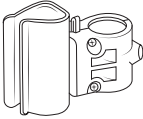
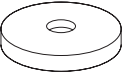
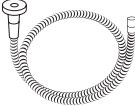
Code	Description	Color	Code	Description	Color
	GR7043 Bag-holder EF/HO with rubber ring			7030 A 7030 R 22 lt rect. bucket	<span style="color: blue;">●</span> <span style="color: red;">●</span>
	1622 Rubber ring large			2252 Lid for 6 lt bucket	<span style="color: gray;">●</span>
	2710 Complete device for bag-holder (with 2 clips item no. 1701)	<span style="color: red;">●</span> <span style="color: gray;">●</span>		2253 Bottles divider for 6 lt bucket	<span style="color: gray;">●</span>
	1675 Broom support			7038 Lid for 22 lt rect. bucket	<span style="color: gray;">●</span>
	7036 Basket for buckets for EF/HO			5024 Bottle divider for H	
	7040 Large basket for EF			4020 Chromed handle Ø 22 mm, 145 cm with hole (2 pieces)	
	7045 Basket for EF/HO			7008 Stainless steel frame - (40x10 cm)	
	2250 A 2250 R 6 lt bucket	<span style="color: blue;">●</span> <span style="color: red;">●</span>		7009 Wet flat mop EF 40x10 cm (color code)	
	2235 A 2235 R 12 lt bucket	<span style="color: blue;">●</span> <span style="color: red;">●</span>		7001 Stainless steel wringer	

	Code	Description	Color
	KIT1635	Kit metal fixing plate	●
	KIT2230	Kit handle holder Ø 22 mm with coupling system	●
	1031	Small bumpers	●
	1071	FAST water hose	
	2034	Castor Ø 80 mm with expander and thread guard	
	7041	Threaded rod EF/HO	





# Multifunctional Trolleys with Rilsan Protection

---

EUROPE

146

---

BIO-R

147

# Multifunctional Trolleys with Rilsan Protection

---





**VDM Rilsan protection.** VDM exclusive excellence is the special Rilsan protection by immersion in fluid bed (protective film thickness 400 micron) which grants a high duration over the time.

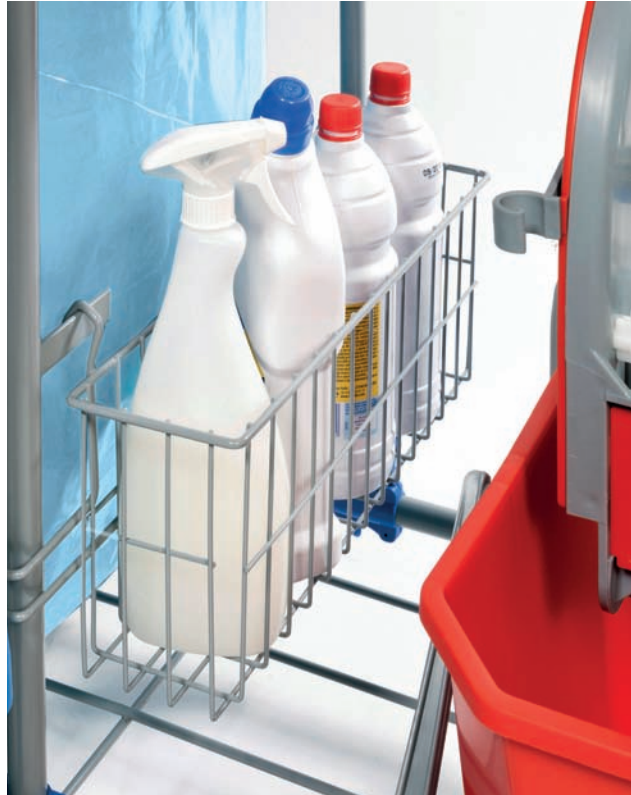

**Loading capacity.** Plenty of loading space in reduced dimensions.

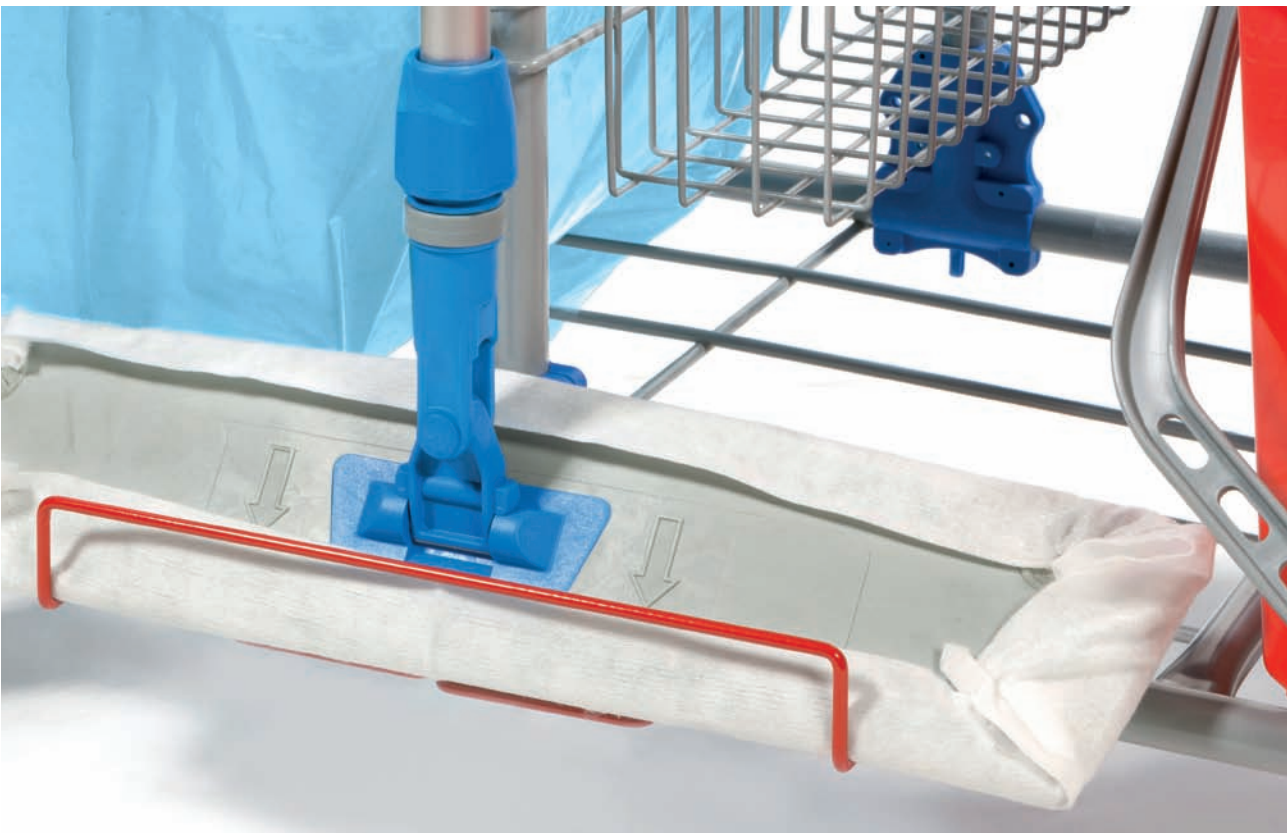

**Functionality.** Broom holder integrated in the trolley for a better functionality.



Code	Description	Color
<b>EUROPE</b>	<b>Trolley EUROPE with rilsan protection</b>	
GR1530/R	1 Base EUROPE in rilsan equipped with 4 castors Ø 80 mm (item no. 1030/ZE) and bumpers	
GR1533/R	1 Vertical frame equipped with small rubber ring for EUROPE	
1666/R	1 Basket in rilsan for EUROPE/IDEABASE	
1535/R	1 Rilsan basket for buckets for EUROPE/IDEABASE	
8311	1 Small handle holder	
2250 A	1x6 lt bucket	●
2250 R	1x6 lt bucket	●
2023 A	1 Tray for MINIMAX	●
KITEUROPE/A	1 Assembling kit for EUROPE	●

Code	Description	Color
<b>EUROPE 2</b>	<b>Trolley EUROPE with rilsan protection</b>	
<b>EUROPE 2 S/P</b>	<b>Trolley EUROPE with rilsan protection without wringer</b>	
GR8051/R	1 Base EUROPE 2 in rilsan equipped with 4 castors Ø 100 mm (item no. 2030) with thread 8x28 and small bumpers	
GR8052/R	1 Rilsan vertical frame for EUROPE 2	
7045/R	1 Rilsan basket for EUROPE 2	
7036/R	1 Basket for buckets for EUROPE 2	
1675	1 Broom support	
2250 A	1x6 lt bucket	●
2250 R	1x6 lt bucket	●
1205 A	1x15 lt bucket	●
1205 R	1x15 lt bucket	●
1980/R	1 Wringer support 2x25 lt rilsan	
4100PR	1 Plastic wringer	●
KITEUROPE/B	1 Assembling kit with 1 handle holder (item no. KIT2230) for EUROPE	●

68x45x100h cm	2 Pcs/carton	22 Kg	0,190 m <sup>3</sup>
---------------	--------------	-------	----------------------

95x50x105h cm	1 Pc/carton	20,7 Kg	0,250 m <sup>3</sup>
	1 Pc/carton	18,4 Kg	0,250 m <sup>3</sup>

**Optional** (shown in the picture)

7031 B	Rectangular lid	●
--------	-----------------	---





Code	Description	Color
<b>BIO-R 1</b>	<b>BIO-R trolley with rilsan protection</b>	
<b>BIO-R 1 S/E</b>	<b>BIO-R trolley with rilsan protection without ELPAROLL system</b>	
GR8301/R	1 Base BIO-R 1 in rilsan equipped with 4 castors Ø 100 mm (item no. 2034) with expander and bumpers	
GR8202/R	2 Rilsan vertical frame for BIO-R	
GR5013/R	1 Rilsan bag holder 120 lt equipped with clips and cover holder (item no. 7031) for BIO-R	
8310	2 Large handle holders	●
GR5014/R	1 Rilsan bag support 120 for BIO-R	
GR8306/R	2 Rilsan trays supports medium for BIO-R	
3503	1 ELPAROLL wet flat mop 45x10 cm	
4020	1 Chromed handle Ø 22 mm, 145 cm with hole (2 pieces)	
3502	1 ELPAROLL frame 45x10 cm	
2250 A	1x6 lt bucket	●
2250 G	1x6 lt bucket	●
2250 R	1x6 lt bucket	●
2250 VS	1x6 lt bucket	●
1205 A	1x15 lt bucket	●
1205 R	1x15 lt bucket	●
2027 A	1 Tray medium	●
2027 R	1 Tray medium	●
2025 A	1 Tray small	●
GR8304/R	1 Rilsan wringer support 2x15 lt for BIO-R	
3501 VDM	1 Roller wringer ELPAROLL	
KITBIOR/A	1 Assembling kit with 1 handle holder (item no. KIT5018) for BIO-R	

Code	Description	Color
<b>BIO-R 2</b>	<b>BIO-R trolley with rilsan protection</b>	
<b>BIO-R 2 S/E</b>	<b>BIO-R trolley with rilsan protection without ELPAROLL system</b>	
GR8305/R	1 Base BIO-R 2 in rilsan equipped with 4 castors Ø 100 mm (item no. 2034) with expander and bumpers	
GR8202/R	2 Rilsan vertical frames for BIO-R	
GR8204/R	1 Rilsan bag holder 70 lt with clips for BIO-R	
8311	1 Small handle holder	●
GR8206/R	1 Bag support 70 lt BIO-R in rilsan	
8303/R	1 Broom support for BIO-R	
GR8205/R	2 Rilsan trays supports mini for BIO-R	
3503	1 ELPAROLL wet flat mop 45x10 cm	
4020	1 Chromed handle Ø 22 mm, 145 cm with hole (2 pieces)	
3502	1 ELPAROLL frame 45x10 cm	
2250 A	1x6 lt bucket	●
2250 R	1x6 lt bucket	●
1205 A	1x15 lt bucket	●
1205 R	1x15 lt bucket	●
2024 A	2 Trays mini	●
2024 R	1 Tray mini	●
3501 VDM	1 Roller wringer ELPAROLL	
GR8304/R	1 Rilsan wringer support 2x15 lt for BIO-R	
KITBIOR/A	1 Assembling kit with 1 handle holder (item no. KIT5018) for BIO-R	

110x60x105h cm	1 Pc/carton	29,8 Kg	0,250 m <sup>3</sup>
	1 Pc/carton	25,5 Kg	0,250 m <sup>3</sup>

100x60x105h cm	1 Pc/carton	25,6 Kg	0,250 m <sup>3</sup>
	1 Pc/carton	21,5 Kg	0,250 m <sup>3</sup>













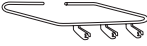
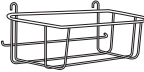
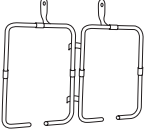

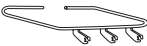



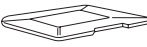

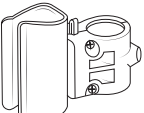

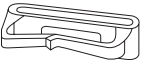
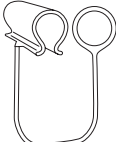
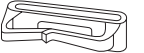
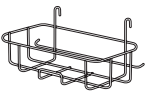
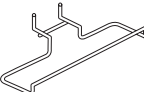

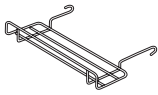
Code	Description	Color
<b>BIO-R 3</b>	<b>BIO-R trolley with rilsan protection</b>	
<b>BIO-R 3 S/E</b>	<b>BIO-R trolley with rilsan protection without ELPAROLL system</b>	
GR8201/R	1 Base BIO-R 3-4 in rilsan equipped with 4 castors Ø 80 mm (item no. 1430) with expander and bumpers	
GR8202/R	2 Rilsan vertical frames for BIO-R	●
GR8204/R	1 Rilsan bag holder 70 lt with clips for BIO-R	
8311	1 Small handle holder	●
GR8206/R	1 Bag support 70 lt BIO-R in rilsan	
8303/R	1 Broom support for BIO-R	●
GR8205/R	2 Rilsan trays supports mini for BIO-R	●
3503	1 ELPAROLL wet flat mop 45x10 cm	●
4020	1 Chromed handle Ø 22 mm, 145 cm with hole (2 pieces)	●
3502	1 ELPAROLL frame 45x10 cm	●
2250 A	1x6 lt bucket	●
2250 R	1x6 lt bucket	●
2235 A	1x12 lt bucket	●
2235 R	1x12 lt bucket	●
2024 A	2 Trays mini	●
2024 R	1 Tray mini	●
3501 VDM	1 Roller wringer ELPAROLL	●
GR8207/R	1 Rilsan wringer support 2x12 lt for BIO-R	
KITBIOR/A	1 Assembling kit with 1 handle holder (item no. KIT5018) for BIO-R	

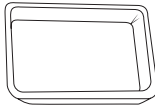

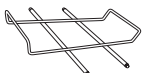

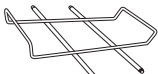
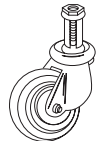
Code	Description	Color
<b>BIO-R 4</b>	<b>BIO-R trolley with rilsan protection</b>	
GR8201/R	1 Base BIO-R 3-4 in rilsan equipped with 4 castors Ø 80 mm (item no. 1430) with expander and bumpers	
GR8202/R	1 Rilsan vertical frame for BIO-R	●
GR8203/R	1 Rilsan vertical frame with handle for BIO-R	
GR8204/R	1 Rilsan bag holder 70 lt with clips for BIO-R	
8311	1 Small handle holder	●
8303/R	1 Broom support for BIO-R	●
GR8205/R	2 Rilsan trays supports mini for BIO-R	●
2250 A	1x6 lt bucket	●
2250 R	1x6 lt bucket	●
2024 A	2 Trays mini	●
2024 R	1 Tray mini	●
KITBIOR/B	1 Assembling kit for BIO-R	

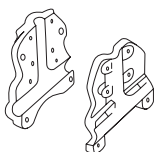
100x40x103h cm	1 Pc/carton	23,4 Kg	0,190 m³
	1 Pc/carton	19,4 Kg	0,190 m³

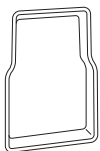
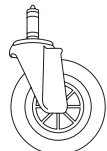
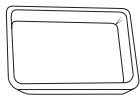
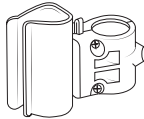
75x40x103h cm	1 Pc/carton	15,5 Kg	0,150 m³
---------------	-------------	---------	----------

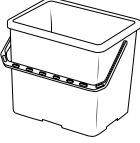
Code	Description	Color	Code	Description	Color
 GR8204/R	Rilsan bag holder 70 lt with clips for BIO-R		 7036/R	Basket for buckets for EUROPE 2	
 GR5027/R	Bag holder DUOx70 lt in rilsan with clips for BIO-R		 7045/R	Rilsan basket for EUROPE 2	
 GR5013/R	Rilsan bag holder 120 lt equipped with clips and cover holder (item no. 7031) for BIO-R		 1032	Small bumpers	●
 5051/B 5051/R	Lid for DUO bag-holder (item no. GR5027)	● ●	 1036/A	Large bumpers	●
 7031 7031 B	Rectangular lid	● ●	 1622	Rubber ring large	
 1386	Rubber ring small		 KIT5018	Kit handle holder Ø 20 mm with coupling system	●
 1621	Plastic clip	●	 8310	Large handle holder	●
 1702	Plastic clip with ring	●	 8311	Small handle holder	●
 1535/R	Rilsan basket for buckets for EUROPE/IDEABASE		 1675	Broom support	

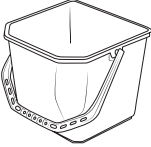
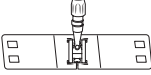
Code	Description	Color	Code	Description	Color
	8303/R Broom support for BIO-R			2025 A Tray small	●
	GR8206/R Bag support 70 lt BIO-R in rilsan			2027 A 2027 R Tray medium	● ●
	GR5014/R Rilsan bag support 120 lt for BIO-R			1030 Castor Ø 80 mm with thread 8x28 and thread guard	
	GR8205/R Rilsan tray support mini for BIO-R			1030/ZE Castor Ø 80 mm with thread 8x40 and thread guard	
	GR8306/R Rilsan tray support medium for BIO-R			1430 Castor Ø 80 mm with expander and thread guard	
	1666/R Basket in rilsan for EUROPE/IDEABASE			2030 Castor Ø 100 mm with thread 8x28 and thread guard	
	KIT1738 Kit plastic fixing-plates for rilsan	●		2034 Castor Ø 80 mm with expander and thread guard	
	2023 A Tray for MINIMAX	●		2075 Soft castor Ø 150 mm without brake with expander	
	2024 A 2024 R Tray mini	● ●		KIT2230 Kit handle holder Ø 22 mm with coupling system	●

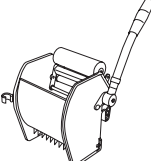
	Code	Description	Color
	2250 A 2250 G 2250 R 2250 VS	6 Lt bucket	● ● ● ●
	2235 A 2235 R	12 Lt bucket	● ●
	1205 A 1205 R	15 Lt bucket	● ●
	3502	ELPAROLL frame - 45x10 cm	
	4100PR	Plastic wringer	●
	3501 VDM	Roller wringer ELPAROLL	



# Multifunctional Stainless Steel Trolleys

---

BIOSTEEL

156

---



# Multifunctional Stainless Steel Trolleys



**Reduced overall dimensions.** A patented system for reducing the overall dimensions of the trolley is among the features of Biosteel line



**Material.** AISI 304 stainless steel makes this line of trolleys extremely robust, long-lasting, suitable to meet any kind of need and ideal for any application.



**Loading capacity.** Equipped with large loading space.





Code	Description	Color
------	-------------	-------

**BIOSTEEL 1**     **Stainless steel trolley BIOSTEEL**



**BIOSTEEL 1 S/P**     **Stainless steel trolley BIOSTEEL without wringer**



GR2700	1 BIOSTEEL 1 base with 2 castors Ø 100 mm (item no. 2034) with expander and large bumpers	
GR2702/STD	1 Long frame with 2 sets of plates and 2 castors Ø 100 mm (item no. 2034) with expander and large bumpers BIOSTEEL 1-3-5-6-7-8-9	
2735	1 Short stainless steel vertical frame	
GR2704	1 Stainless steel bag holder with rubber ring	
7031	1 Rectangular lid	●
2705	1 Stainless steel bag support	
2025 A	1 Tray small	●
2027 A	1 Tray medium	●
2027 R	1 Tray medium	●
2706	4 Long stainless steel bars with rod	●
2250 A	1x6 lt bucket	●
2250 G	1x6 lt bucket	●
2250 R	1x6 lt bucket	●
2250 VS	1x6 lt bucket	●
1205 A	1x15 lt bucket	●
1205 R	1x15 lt bucket	●
2708	1 Wringer support for BIOSTEEL	●
4100PA	1 Plastic wringer	●
8311	2 Small handle holders	●
KITBIOSTEEL/A	1 Assembling kit BIOSTEEL 1 with 1 handle holder (item no. KIT2230)	

Code	Description	Color
------	-------------	-------

**BIOSTEEL 2**     **Stainless steel trolley BIOSTEEL**

GR2711	1 BIOSTEEL 2-3-4 base with 2 castors Ø 100 mm (item no. 2034) with expander and large bumpers	
GR2702/100	1 Long frame with 2 castors Ø 100 mm (item no. 2034) with expander and large bumpers	
GR2735/STD	1 Short frame with fixing plates BIOSTEEL 2-3-10	
GR2704	1 Stainless steel bag holder with rubber ring	
7031	1 Rectangular lid	●
2025 A	2 Trays small	●
2025 R	1 Tray small	●
2706	2 Long stainless steel bars with rod	●
2707	2 Long stainless steel bars	●
2250 A	1x6 lt bucket	●
2250 R	1x6 lt bucket	●
8311	2 Small handle holders	●
KITBIOSTEEL/B	1 Assembling kit BIOSTEEL 2-3	

 125x60x108h cm (90x60x140h cm)	 1 Pc/carton	25,8 Kg	0,250 m <sup>3</sup>
	 1 Pc/carton	23,5 Kg	0,250 m <sup>3</sup>

 90x60x108h cm	 1 Pc/carton	17,5 Kg	0,250 m <sup>3</sup>
---	---	---------	----------------------





Code	Description	Color
------	-------------	-------

BIOSTEEL 3		Stainless steel trolley BIOSTEEL
GR2711	1 BIOSTEEL 2-3-4 base with 2 castors Ø 100 mm (item no. 2034) with expander and large bumpers	
GR2702/STD	1 Long frame with 2 sets of plates and 2 castors Ø 100 mm (item no. 2034) with expander and large bumpers BIOSTEEL 1-3-5-6-7-8-9	
GR2735/STD	1 Short frame with fixing plates BIOSTEEL 2-3-10	
GR2704	1 Stainless steel bag holder with rubber ring	
7031	1 Rectangular lid	●
2025 A	2 Trays small	●
2025 R	1 Tray small	●
2706	2 Long stainless steel bars with rod	●
2707	2 Long stainless steel bars	●
2250 A	1x6 lt bucket	●
2250 R	1x6 lt bucket	●
2270 A	2x13 lt rect. buckets	●
2733	2 Stainless steel supports for 13 lt bucket	●
8311	2 Small handle holders	●
KITBIOSTEEL/B	1 Assembling kit BIOSTEEL 2-3	

Code	Description	Color
------	-------------	-------

BIOSTEEL 5		Stainless steel trolley BIOSTEEL
GR2714	1 BIOSTEEL 5 base equipped 2 castors Ø 100 mm (item no. 2034) with expander and large bumpers	
GR2702/STD	1 Long frame with 2 sets of plates and 2 castors Ø 100 mm (item no. 2034) with expander and large bumpers BIOSTEEL 1-3-5-6-7-8-9	
2735	1 Short stainless steel vertical frame	
GR2704	1 Stainless steel bag holder with rubber ring	
7031	1 Rectangular lid	●
2705	1 Stainless steel bag support	●
2025 A	1 Tray small	●
2027 A	1 Tray medium	●
2027 R	1 Tray medium	●
2706	4 Long stainless steel bars with rod	●
2250 A	1x6 lt bucket	●
2250 G	1x6 lt bucket	●
2250 R	1x6 lt bucket	●
2250 VS	1x6 lt bucket	●
5029/PL	1 Plastic basket with holes for tank (item no.5028)	●
5028	1x35 lt plastic tank	
8311	2 Small handle holders	●
KITBIOSTEEL/D	1 Assembling kit BIOSTEEL 5 with 1 handle holder (item no. KIT2230)	

	120x60x108h cm (90x60x140h cm)		1 Pc/carton	21,8 Kg	0,250 m <sup>3</sup>
--	-----------------------------------	--	-------------	---------	----------------------

	125x60x108h cm (90x60x140h cm)		1 Pc/carton	24,2 Kg	0,250 m <sup>3</sup>
--	-----------------------------------	--	-------------	---------	----------------------



Code	Description	Color
------	-------------	-------

**BIOSTEEL 6**    **Stainless steel trolley BIOSTEEL**

**BIOSTEEL 6 S/P**    **Stainless steel trolley BIOSTEEL without wringer**

GR2712/N	1 BIOSTEEL 6 base equipped with 2 castors Ø 100 mm (item no. 2034) with expander and large bumpers	
GR2702/STD	1 Long frame with 2 sets of plates and 2 castors Ø 100 mm (item no. 2034) with expander and large bumpers BIOSTEEL 1-3-5-6-7-8-9	
2735	1 Short stainless steel vertical frame	
GR2704	1 Stainless steel bag holder with rubber ring	●
7031	1 Rectangular lid	●
2705	1 Stainless steel bag support	●
2025 A	1 Tray small	●
2027 A	1 Tray medium	●
2027 R	1 Tray medium	●
2706	4 Long stainless steel bars with rod	●
2250 A	1x6 lt bucket	●
2250 G	1x6 lt bucket	●
2250 R	1x6 lt bucket	●
2250 VS	1x6 lt bucket	●
7030 R	1x22 lt rect. bucket	●
2736	1 Stainless steel wringer support (for item no.7001)	
7001	1 Stainless steel wringer	
8311	2 Small handle holders	●
KITBIOSTEEL/E	1 Assembling kit BIOSTEEL 6-7 with 1 handle holder (item no. KIT2230)	

Code	Description	Color
------	-------------	-------

**BIOSTEEL 7**    **Stainless steel trolley BIOSTEEL**

**BIOSTEEL 7 S/P**    **Stainless steel trolley BIOSTEEL without wringer**

GR2712	1 BIOSTEEL 7 base equipped with 2 castors Ø 100 mm (item no. 2034) with expander and large bumpers	
GR2702/STD	1 Long frame with 2 sets of plates and 2 castors Ø 100 mm (item no. 2034) with expander and large bumpers BIOSTEEL 1-3-5-6-7-8-9	
2735	1 Short stainless steel vertical frame	
GR2704	1 Stainless steel bag holder with rubber ring	●
7031	1 Rectangular lid	●
2705	1 Stainless steel bag support	●
2025 A	1 Tray small	●
2027 A	1 Tray medium	●
2027 R	1 Tray medium	●
2706	4 Long stainless steel bars with rod	●
2250 A	1x6 lt bucket	●
2250 G	1x6 lt bucket	●
2250 R	1x6 lt bucket	●
2250 VS	1x6 lt bucket	●
7030 A	1x22 lt rect. bucket	●
7030 R	1x22 lt rect. bucket	●
2720	1 Stainless steel 22 lt bucket holder	
2736	1 Stainless steel wringer support (for item no.7001)	
7001	1 Stainless steel wringer	
8311	2 Small handle holders	●
KITBIOSTEEL/E	1 Assembling kit BIOSTEEL 6-7 with 1 handle holder (item no. KIT2230)	



<b>125x60x108h cm</b> <b>(90x60x140h cm)</b>	1 Pc/carton	29,4 Kg	0,250 m <sup>3</sup>
	1 Pc/carton	22,6 Kg	0,250 m <sup>3</sup>

<b>145x60x108h cm</b> <b>(93x60x140h cm)</b>	1 Pc/carton	32 Kg	0,250 m <sup>3</sup>
	1 Pc/carton	25,2 Kg	0,250 m <sup>3</sup>



Code	Description	Color
<b>BIOSTEEL 8</b>	<b>Stainless steel trolley BIOSTEEL</b>	
<b>BIOSTEEL 8 S/P</b>	<b>Stainless steel trolley BIOSTEEL without wringer</b>	
GR2715	1 BIOSTEEL 8 base equipped with 2 castors Ø 100 mm (item no. 2034) with expander and large bumpers	
GR2702/STD	1 Long frame with 2 sets of plates and 2 castors Ø 100 mm (item no. 2034) with expander and large bumpers BIOSTEEL 1-3-5-6-7-8-9	
2735	1 Short stainless steel vertical frame	
GR2704	1 Stainless steel bag holder with rubber ring	
7031	1 Rectangular lid	●
2022 A	1 Tray narrow	●
2022 R	1 Tray narrow	●
2024 A	1 Tray mini	●
2719	4 Short stainless steel bars with rod	●
2250 A	1x6 lt bucket	●
2250 R	1x6 lt bucket	●
1205 A	1x15 lt bucket	●
1205 R	1x15 lt bucket	●
2705	1 Stainless steel bag support	●
2708	1 Wringer support for BIOSTEEL	
4100PA	1 Plastic wringer	●
KITBIOSTEEL/G	1 Assembling kit BIOSTEEL 8-9 with 5 handle holders (1x item no. KIT2230 + 4x item no. 2255)	

Code	Description	Color
<b>BIOSTEEL 9</b>	<b>Stainless steel trolley BIOSTEEL</b>	
<b>BIOSTEEL 9 S/P</b>	<b>Stainless steel trolley BIOSTEEL without wringer</b>	
GR2717	1 BIOSTEEL 9 base equipped with 2 castors Ø 100 mm (item no. 2034) with expander and large bumpers	
GR2702/STD	1 Long frame with 2 sets of plates and 2 castors Ø 100 mm (item no. 2034) with expander and large bumpers BIOSTEEL 1-3-5-6-7-8-9	
2735	1 Short stainless steel vertical frame	
GR2704	1 Stainless steel bag holder with rubber ring	
7031	1 Rectangular lid	●
2705	1 Stainless steel bag support	
2022 A	1 Tray narrow	●
2022 R	1 Tray narrow	●
2024 A	1 Tray mini	●
2719	4 Short stainless steel bars with rod	●
2235 A	1x12 lt bucket	●
2235 R	1x12 lt bucket	●
2250 A	1x6 lt bucket	●
2250 R	1x6 lt bucket	●
2708	1 Wringer support for BIOSTEEL	
4100PA	1 Plastic wringer	●
KITBIOSTEEL/G	1 Assembling kit BIOSTEEL 8-9 with 5 handle holders (1x item no. KIT2230 + 4x item no. 2255)	

 100x60x108h cm (70x60x140h cm)	 1 Pc/carton	24 Kg	0,250 m <sup>3</sup>
	 1 Pc/carton	21,6 Kg	0,250 m <sup>3</sup>

 100x45x108h cm (70x45x140h cm)	 1 Pc/carton	22,4 Kg	0,250 m <sup>3</sup>
	 1 Pc/carton	20 Kg	0,250 m <sup>3</sup>





Code	Description	Color
------	-------------	-------

**BIOSTEEL 10 Stainless steel trolley BIOSTEEL**

- GR2718 1 BIOSTEEL 10 base equipped with 2 castors  
Ø 80 mm (item no. 1430) with expander and bumpers
- GR2702/80 1 Long frame with 2 castors Ø 80 mm (item no.1430)  
with expander and big bumpers
- GR2735/STD 1 Short frame with fixing plates BIOSTEEL 2-3-10
- GR2704 1 Stainless steel bag holder with rubber ring
- 7031 1 Rectangular lid
- 2022 A 1 Tray narrow
- 2022 R 1 Tray narrow
- 2024 A 1 Tray mini
- 2719 4 Short stainless steel bars with rod
- 2250 A 1x6 lt bucket
- 2250 R 1x6 lt bucket
- KITBIOSTEEL/H 1 Assembling kit BIOSTEEL 10 with 2 handle holders  
(item no. 2255)



Code	Description	Color
------	-------------	-------

**BIOSTEEL 11 Stainless steel trolley BIOSTEEL**

- GR2760 1 Small stainless steel frame with 4 castors  
Ø 125 mm (item no. 2050) with bumpers  
and 4 sets of aluminum plates
- GR2759 1 Short stainless steel pushing handle
- GR2704 1 Stainless steel bag holder with rubber ring
- 2710 1 Complete device for bag-holder  
(with 2 clips code 1701)
- 7031 B 1 Rectangular lid EF/HO
- 2022 R 1 Tray narrow
- 2025 A 1 Tray small
- 2027 A 1 Tray medium
- 2752 1 Stainless steel tray holder
- 2250 A 1x6 lt bucket
- 2250 R 1x6 lt bucket
- 7030 R 1x22 lt rect. bucket
- 2720 1 Stainless steel 22 lt bucket holder
- 2028 2 Sliding boxes for BIOSTEEL 11-12
- 8311 1 Small handle holder
- KITBIOSTEEL/I 1 Assembling kit BIOSTEEL 11-12 with 2 handle  
holders (item no. 2255)



Production to order (Min. 20 pcs)



70x45x106h cm	1 Pc/carton	15 Kg	0,150 m <sup>3</sup>
---------------	-------------	-------	----------------------



120x60x120h cm	1 Pc/carton	26 Kg	0,430 m <sup>3</sup>
----------------	-------------	-------	----------------------













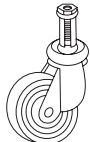



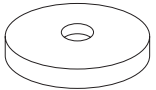
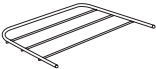
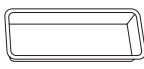
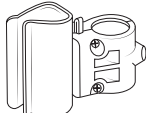

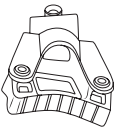
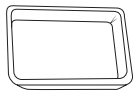
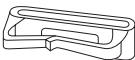
Code	Description	Color
<b>BIOSTEEL 12</b>	<b>Stainless steel trolley BIOSTEEL</b>	
GR2760	1 Small stainless steel frame with 4 castors Ø 125 mm (item no. 2050) with bumpers and 4 sets of aluminum plates	
GR2759	1 Short stainless steel pushing handle	
GR2770	1 Double stainless steel bag holder with rubber rings	
2710	1 Complete device for bag-holder (with 2 clips code 1701)	● ●
7031 B	1 Rectangular lid EF/HO	●
7031	1 Rectangular lid EF/HO	●
2022 R	1 Tray narrow	●
2025 A	1 Tray small	●
2027 A	1 Tray medium	●
2752	1 Stainless steel tray holder	
2250 A	1x6 lt bucket	●
2250 R	1x6 lt bucket	●
7030 R	1x22 lt rect. bucket	●
2720	1 Stainless steel 22 lt bucket holder	
2028	2 Sliding boxes for BIOSTEEL 11-12	
8311	1 Small handle holder	●
KITBIOSTEEL/I	1 Assembling kit BIOSTEEL 11-12 with 2 handle holders (item no. 2255)	
<b>Production to order (Min. 20 pcs)</b>		

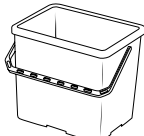
Code	Description	Color
<b>BIOSTEEL X</b>	<b>Stainless steel trolley BIOSTEEL X</b>	
GRBIOSTEELX	1 BIOSTEEL X stainless steel trolley structure with 4 castors Ø 80 mm (item no. 1430) and bumpers	
1680/G	1 Sanforized canvas bag 230 lt	

 135x60x124h cm |  1 Pc/carton 30 Kg 0,430 m<sup>3</sup>

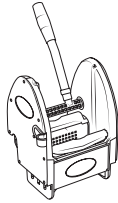
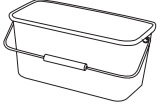
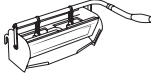
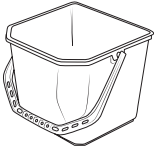
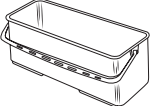
 53x50x104h cm |  2 Pcs/carton 15 Kg 0,175 m<sup>3</sup>

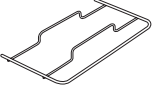
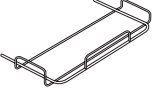
Code	Description	Color	Code	Description	Color
 GR2704	Stainless steel bag holder with rubber ring		 1430	Castor Ø 80 mm with expander and thread guard	
 2770	Stainless steel DUO bag holder 120 lt without covers		 2034	Castor Ø 80 mm with expander and thread guard	
 1622	Rubber ring large		 1032	Small bumpers	●
 7031	Rectangular lid	●	 1036/A	Large bumpers	●
 2705	Stainless steel bag support		 2022 A 2022 R	Tray narrow	● ●
 KIT2230	Kit handle holder Ø 22 mm with coupling system	●	 2024 A	Tray mini	●
 2255	Rubber handle holder with coupling system Ø 22 mm		 2025 A 2025 R	Tray small	● ●
 8311	Small handle holder	●	 2027 A 2027 R	Tray medium	● ●
 1680/G	Sanforized canvas bag 230 lt		 2250 A 2250 G 2250 R 2250 VS	6 lt bucket	● ● ● ●

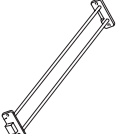
Code	Description	Color	Code	Description	Color
 2235 A 2235 R	12 Lt bucket	<span style="color: blue;">●</span> <span style="color: red;">●</span>	 4100PA	Plastic wringer	<span style="color: blue;">●</span>
 2270 A	13 Lt rect. bucket	<span style="color: blue;">●</span>	 7001	Stainless steel wringer	
 1205 A 1205 R	15 Lt bucket	<span style="color: blue;">●</span> <span style="color: red;">●</span>			
 7030 A 7030 R	22 Lt rect. bucket	<span style="color: blue;">●</span> <span style="color: red;">●</span>			
 KIT2701	Kit of aluminum plates for BIOSTEEL				
 2733	Stainless steel support for 13 Lt bucket				
 2720	Stainless steel 22 Lt bucket holder				
 2723	Basket for bottles				
 2736	Stainless steel wringer support (for item no. 7001)				



# Wringers





# Wringers



**Simplicity and resistance.** Plastic mop wringer with spindle made of aluminum alloy and equipped with hook for handle.



**Innovation.** ELPAROLL roller wringer made of reinforced polypropylene copolymer with AISI 304 stainless steel mechanism and polyurethane elastic rolls. It is possible to rinse the flat mop directly through the wringer.







**Tradition.** Stainless steel wringer.





**Robustness.** Plastic wringer with galvanized steel basket, equipped with adapter.



**Microroll.** MICROROLL roller wringer for microfiber cloths and average cloths. It can be used with the 6 lt bucket and with the 15 lt COMFORT bucket (without wringing sieve).

	Code	Description	Carton	Volume/Weight carton m <sup>3</sup> /kg
	<b>Plastic</b>			
	<b>4100PB</b> ● <b>4100PR</b> ●	Plastic wringer for Kentucky mops with aluminum alloy drive shaft, equipped with handle holder	6	0,185/15,8
	<b>3070 P</b>	Plastic adapter for wringer 4100P	200	0,185/22
	<b>4300 P</b>	Plastic wringer maxi for Kentucky mops up to 600 g complete with plastic adapter	6	0,185/20
	<b>Plastic/ Galvanized steel</b>			
	<b>3000 Z</b>	Plastic wringer with galvanized steel basket, complete with adapter	6	0,185/27
	<b>Plastic/Stainless steel (AISI 304)</b>			
	<b>3501 VDM</b>	ELPAROLL roller wringer made of reinforced polypropylene copolymer, stainless steel AISI 304 mechanism, elastic polyurethane rollers	6	0,155/22
	<b>Plastic</b>			
	<b>4601</b>	Plastic roller wringer for semi-professional use	6	0,155/16

Code	Description	Carton	Volume/Weight carton m <sup>3</sup> /kg
<b>Plastic/Stainless steel (AISI 304)</b>			
 4550	MICROROLL roller wringer for microfibre cloths and cloths in general. Easy to place onto the 6 lt bucket (item no. 2250) and onto 15 lt COMFORT S/S bucket	10	0,100/16
 4575	MICROROLL roller wringer for microfibre cloths and cloths in general can be placed onto the 22 lt bucket only (item no. 7030)	10	0,100/17
<b>Stainless steel (AISI 304)</b>			
 7001	Stainless steel wringer	3	0,150/22



# Buckets and Plastic Components

---



# Buckets and Plastic Components



**Innovation VDM.** Tecno-shower dispenser in polypropylene copolymer for a perfect and uniform pre-impregnation of wet flat mops. The bottom is inclined for an optimal distribution of the solution.







**Tecno-shower.** Holes with different shape and diameter, central relieves for an easier "drop-distribution" of the solution. Positioning hooks on the bucket edge (bucket capacity 22 lt) and hooks to hang the dispenser on the frontal part of the bucket.













**Touch Free System.** Professional cleaning system (patent pending) to be used with trolleys equipped with a pre-impregnation washing method. It is composed of 1 frame for wet flat mop with pockets, 2 clamps to be placed on the 22 ltrs bucket (for the collection of the dirty flat mops) to help unlock the flat mop from the frame without touching with the hands nor the frame, nor the dirty flat mop.







**Advantages.** Thanks to the new Touch Free System, the wet flat mops are unlocked directly in the waste bucket, in an easy and ergonomic way, without using the hands: no release of dirt on the floor, no inhalation of bacteria, germ or dirt for the operator, no contact between the operator and the flat mops and/or the frame, remarkable reduction of cross contamination.





	Code	Description	Carton	Volume/Weight carton m <sup>3</sup> /kg
	23020 B ● 23020 G ● 23020 R ● 23020 VS ●	4 Lt bucket 24x17/9x22h cm		
	2250 A ● 2250 B ● 2250 R ● 2250 G ● 2250 VS ●	6 Lt bucket 26x19x22h cm	50	0,185/26
	2252 ●	Lid for 6 Lt bucket		
	2253 ●	Bottles divider for 6 Lt bucket		
	23021 ●	Lid for 4 Lt bucket		





	Code	Description	Carton	Volume/Weight carton m <sup>3</sup> /kg
	4635 ● 4635/R ●	8 lt bucket 30x19/13x25h cm	20	0,120/10
	2235 A ● 2235 R ●	12 lt bucket 31x24,5x26h cm	20	0,120/14,5
	1205 A ● 1205 R ●	15 lt bucket 34x34x27,5h cm	12	0,145/13,5
	21005 B ● 21005 R ●	15 lt bucket for IDEA 31,5x32/20x33h cm	10	0,145/20
	1005 A ● 1005 R ●	25 lt bucket 34x35,5x32h cm	10	0,165/14





	Code	Description	Carton	Volume/Weight carton m <sup>3</sup> /kg
	2270 A ● 2270 R ●	13 lt rect. bucket 47x22x21h cm	25	0,150/23,5
	7030 A ● 7030 R ● 7030 B ●	22 lt rect. bucket 54x27x27h cm	6	0,120/8,7
	7038 ●	Lid for 22 lt rect. bucket	10	0,047/4,25
	1085 A ●	Double bucket equipped with wringing sieve	5	0,076/7,1
	COMFORT A ● COMFORT G ● COMFORT R ● COMFORT V ●  COMFORT S/S	15 lt COMFORT bucket with wringing sieve    15 lt COMFORT bucket without wringing sieve	10	0,060/9,1    0,060/8





	Code	Description	Carton	Volume/Weight carton m <sup>3</sup> /kg
	GIPSY A/G ● ●	Multipurpose set GIPSY, equipped with 5 removable dividing walls, 4 removable handle-holders	2	0,100/8
	2306 ●	Window bucket for GIPSY 47x12x30h cm		
	2310	Strap for GIPSY		
	7080 ●	Tecno-Shower dispenser		
	2024 A ● 2024 R ●	Tray Mini 40x26x8h cm		



	Code	Description	Carton	Volume/Weight carton m <sup>3</sup> /kg
	2025 A ● 2025 R ●	Tray Small 45x40x8h cm		
	2027 A ● 2027 R ●	Tray Medium 50x40x8h cm		
	2026 A ● 2026 R ●	Tray Large 63x40x8h cm		
	2022 A ● 2022 R ●	Tray Narrow 50x20x8h cm		
	2023 A ●	Tray for MINIMAX 32/38x54x8h cm		

	Code	Description	Carton	Volume/Weight carton m <sup>3</sup> /kg
	21010 B ● 21010 R ●	Tray IDEA 45x26x9h cm		
	21070 B ● 21070 R ●	Maxi tray with 4 handle holders for IDEA 61x39x9h cm		
	23015 GR ○	Tray for MX 42x28x8,5h cm		
	24051 ● 24051 GT ○	Plastic bucket holder for IDEA 53x20x12h cm		
	24053 ● 24053 GT ○	Plastic basket for IDEA 52x14x12h cm		

	Code	Description	Carton	Volume/Weight carton m <sup>3</sup> /kg
	2710	● ● Plastic device for rect. bag holder (with 2 clips item no. 1701)		
	8310	● Large handle holder		
	8311 8311/R	● ● Small handle holder		
	2255	Rubber handle holder with coupling system Ø 22 mm		
	5065	Rubber handle holder with coupling system Ø 20 mm		

Code	Description	Carton	Volume/Weight carton m <sup>3</sup> /kg
	<p><b>4022</b> Threaded joint for handle Ø 22 mm Adaptable to the handle item no.4020</p> <p><b>4024</b> Threaded joint for handle Ø 24 mm Adaptable to the handles item no. 4025-4421</p>		
	<p><b>KIT5018/G</b> ● Hook with coupling system Ø 20 mm</p> <p><b>KIT2231</b> ● Hook with coupling system Ø 22 mm</p> <p><b>KIT2234</b> ● Hook with coupling system Ø 24 mm</p>		
	<p><b>KIT2230</b> ● Kit handle holder Ø 22 mm with coupling system</p> <p><b>KIT5018</b> ● Kit handle holder Ø 20 mm with coupling system</p>		
	<p><b>1701</b> ● Plastic clip with ring</p> <p><b>1702</b> ●</p>		



# Plastic Containers

---



# Plastic Containers

---







**Versatile and ergonomic.** They are available in 90, 70, 45, 40, 30, 20, 12, 6 and 3 lt capacity, they are equipped with pedal operated cover opening.



**Colored.** Covers in different colors are available for a waste collection meeting every need.





	Code	Description	Carton	Volume/Weight carton m <sup>3</sup> /kg
	25001 BI ○ 25001 B ● 25001 R ● 25001 V ● 25001 GI ●	Plastic white container FORMULA - 90 lt foot operated lid* (possibility to choose the color of the lid)	3	0,211/16
				* (the cover can not be sold separately)
	25002 BI ○ 25002 B ● 25002 R ● 25002 V ● 25002 GI ●	Plastic white container FORMULA - 70 lt foot operated lid* (possibility to choose the color of the lid)	3	0,168/14
				* (the cover can not be sold separately)
	25003 BI ○ 25003 B ● 25003 R ● 25003 V ● 25003 GI ●	Plastic white container FORMULA - 45 lt foot operated lid* (possibility to choose the color of the lid)	3	0,138/9,5
				* (the cover can not be sold separately)
	25004 BI ○ 25004 B ● 25004 R ● 25004 V ● 25004 GI ●	Plastic white container FORMULA - 30 lt foot operated lid* (possibility to choose the color of the lid)	4	0,136/10,2
				* (the cover can not be sold separately)
	25011 25012 25013 25014 25015	Plastic container TOP - 3 lt - foot operated lid Plastic container TOP - 6 lt - foot operated lid Plastic container TOP - 12 lt - foot operated lid Plastic container TOP - 20 lt - foot operated lid Plastic container TOP - 40 lt - foot operated lid	12 6 6 2 1	0,088/5 0,088/5 0,154/7 0,100/4,1 0,132/3,5





# Frames and Dust Flat Mops

---



# Frames and dust flat mops

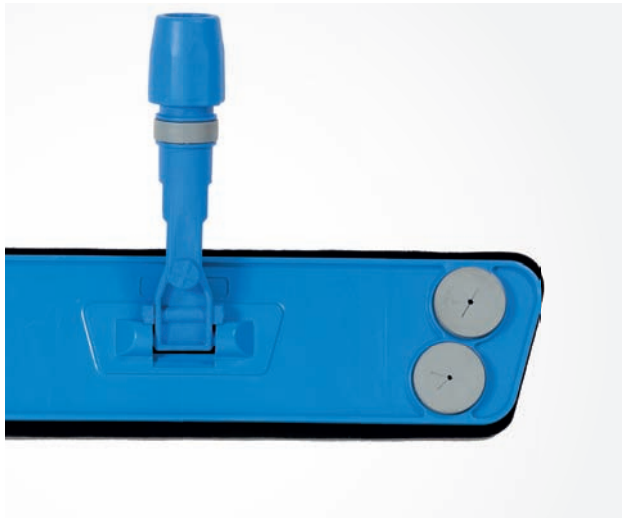

## Frame with foam bottom for disposable cloths.

Plastic frame for disposable cloths available in various dimensions. Equipped with four star-shaped cloth fixing points. The spare foam is available.

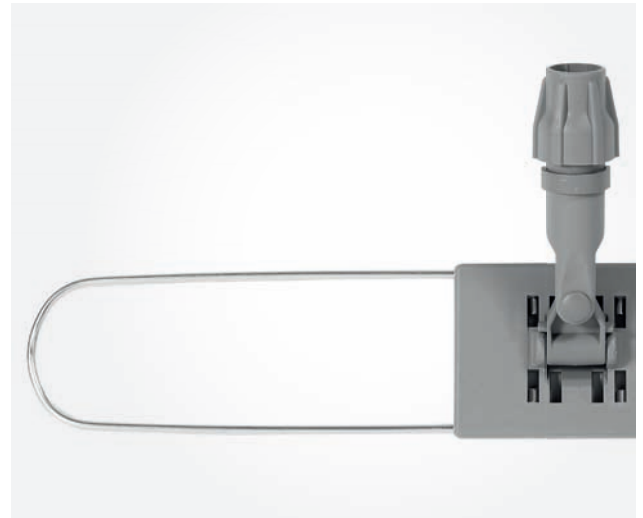

**Folding frame for dust flat mops.** Folding frame for an easy insert of the dust flat mop. Available in various dimensions.



**Scissor frame.** Scissor frame with wooden or metal brackets for scissor mop.

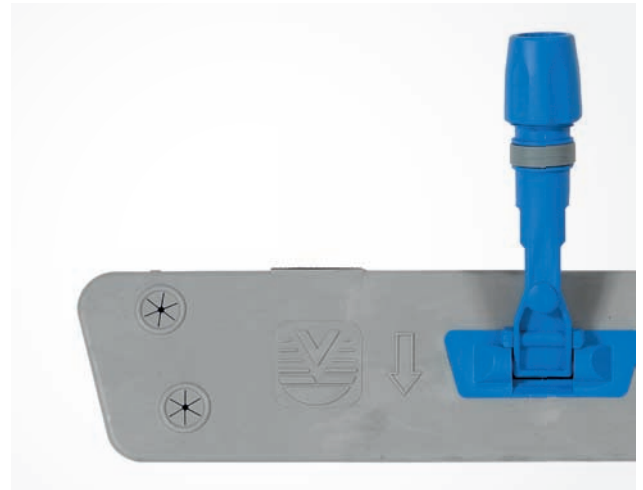

## Dust frame with lamellar bottom plate for disposable cloths.

Frame in polyurethane foam for impregnated or electrostatic cloths. It is autoclavable at 120°.



**Simple.** Equipped with four star-shaped inserts and with two velcro inserts for a fast fixing operation of the cloth.

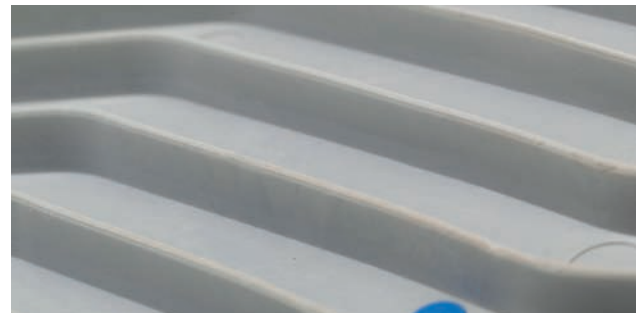

**Stability, flexibility and grip.** Lamellar bottom for an optimal grip to the floor. It matches perfectly with any kind of floor, keeping this feature unchanged over the time.

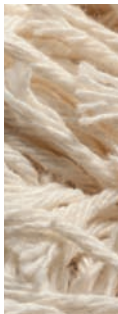

**Material:** COTTON

**Advantages:** it grants a high dirt absorption.

**Area of use:** most suitable to clean large surfaces (fitness centers, shopping malls, airports) and in presence of rough dirt.



Do not use softener



**Material:** ACRYLIC

**Advantages:** acrylic flat mops with high electrostatic charge.

**Area of use:** most suitable to clean large surfaces (fitness centers, shopping malls, airports) and in presence of rough dirt.



Do not use softener

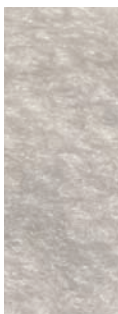

#### IMPREGNATED CLOTHS

**Material:** 100% Polypropylene (impregnation 20%).

**Advantages:**

- it reduces the bacterial count;
- it doesn't raise the dust;
- it doesn't damage the wax;
- quick operation;
- little effort of the operator.

**Area of use:** most suitable to clean sanitary environments, for accurate cleaning and in presence of medium dirt.

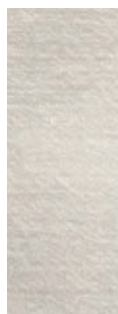





#### ELECTROSTATIC CLOTHS





**Material:** 100% Polyester

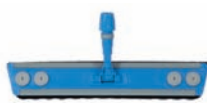



**Advantages:**



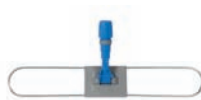

- it reduces the bacterial count;
- it doesn't raise the dust;
- it doesn't damage the wax;
- quick operation;
- little effort of the operator.

**Area of use:** most suitable to clean sanitary environments, for accurate cleaning and in presence of medium dirt.



	Code	Description	Carton	Volume/Weight carton m <sup>3</sup> /kg
	4087	Rubber dust frame for disposable cloths (60 cm), with two velcro and four plastic inserts for a quick fixing of the disposable cloth	25	0,150/24
	4085/N	Dust frame for disposable cloths with foam - 40 cm	25	0,065/8,5
	4086/N	Dust frame for disposable cloths with foam - 50 cm		0,080/9,8
	4085/SPN	Replacement foam - 40 cm	25	
	4086/SPN	Replacement foam - 50 cm		
	4086	Dust frame for disposable cloths with foam - 60 cm	25	0,065/6,3
	4086/SPU	Replacement foam 60 cm	25	

	Code	Description	Carton	Volume/Weight carton m <sup>3</sup> /kg
	<b>4181</b> <b>4182</b> <b>4183</b> <b>4184</b>	Disposable impregnated dust cloth - 60x17 cm Disposable impregnated dust cloth - 60x20 cm Disposable impregnated dust cloth - 60x30 cm Disposable impregnated dust cloth - 60x22 cm	20x50	0,030/2,8 0,030/3,2 0,045/5,4 0,030/3,5
	<b>6020</b> <b>6030</b>	Electrostatic dust cloth - 60x20 cm Electrostatic dust cloth - 60x30 cm  (100% polyester)	20x50	0,095/9,7 0,125/13
	<b>6041</b> <b>60642</b> <b>6042</b> <b>6043</b> <b>60641</b>	Cotton gauze with central hole for wet mopping - 60x80 cm Cotton gauze with central hole for wet mopping - 90x80 cm Cotton gauze with central hole for wet mopping - 100x80 cm Cotton gauze with central hole for wet mopping - 120x80 cm Cotton gauze with central hole for wet mopping - 140x80 cm	200	0,036/6 0,046/9 0,071/10,3 0,067/11 0,071/12,6
	<b>4041</b> <b>4042</b> <b>4043</b> <b>4044</b>	Folding frame - 40 cm Folding frame - 60 cm Folding frame - 80 cm Folding frame - 100 cm	25	0,034/6,7 0,050/8,3 0,062/11,2 0,080/21,3
	<b>4041/N</b> <b>4042/N</b> <b>4043/N</b>	Folding frame - 40 cm Folding frame - 60 cm Folding frame - 80 cm	25	0,036/7,5 0,055/10,6 0,072/15,2

	Code	Description	Carton	Volume/Weight carton m <sup>3</sup> /kg
	4041/M	Metal folding frame - 40 cm	25	0,033/9,5
	4042/M	Metal folding frame - 60 cm		0,049/12
	4043/M	Metal folding frame - 80 cm		0,064/15,2
	4045	Metal fixed frame - 110 cm	10	0,022/16,2
	4046	Metal fixed frame - 130 cm		0,022/16,8
	4047	Metal fixed frame - 160 cm		0,030/18,7
	4071	Complete scissor mop (2 mt) with wooden brackets	10	0,32/50
	4071/M	Complete scissor mop (2 mt) with metal brackets		
	4073	Scissor frame with wooden brackets	10	0,124/21,2
	4073/M	Scissor frame with metal brackets	10	0,124/21,2

Code	Description	Carton	Volume/Weight carton m <sup>3</sup> /kg
	<b>4074</b> Scissor mop handle	5	0,060/9,6
<b>Cotton (with pockets)</b>			
	<b>4131</b> Dust cotton flat mop with pockets - 40 cm <b>4132</b> Dust cotton flat mop with pockets - 60 cm <b>4133</b> Dust cotton flat mop with pockets - 80 cm <b>4134</b> Dust cotton flat mop with pockets - 100 cm	25	0,025/4 0,034/6,2 0,044/7,8 0,054/9,8
<b>Synthetic (with pockets)</b>			
	<b>4141</b> Dust synthetic flat mop with pockets - 40 cm <b>4142</b> Dust synthetic flat mop with pockets - 60 cm <b>4143</b> Dust synthetic flat mop with pockets - 80 cm <b>4144</b> Dust synthetic flat mop with pockets - 100 cm	25	0,025/3,7 0,034/5,5 0,044/6,8 0,054/8,2
<b>Cotton (with strings)</b>			
	<b>4051</b> Dust cotton flat mop with strings - 40 cm <b>4052</b> Dust cotton flat mop with strings - 60 cm <b>4053</b> Dust cotton flat mop with strings - 80 cm <b>4054</b> Dust cotton flat mop with strings - 100 cm <b>4055</b> Dust cotton flat mop with strings - 110 cm <b>4056</b> Dust cotton flat mop with strings - 130 cm <b>4057</b> Dust cotton flat mop with strings - 160 cm <b>4072</b> Dust cotton flat mop with strings (2x1 mt) for scissor mop	25 25 25 25 25 25 25 10	0,025/4 0,034/6,2 0,044/7,8 0,054/9,8 0,075/10 0,075/11 0,075/12 0,075/9,2
<b>Synthetic (with strings)</b>			
	<b>4061</b> Dust synthetic flat mop with strings - 40 cm <b>4062</b> Dust synthetic flat mop with strings - 60 cm <b>4063</b> Dust synthetic flat mop with strings - 80 cm <b>4064</b> Dust synthetic flat mop with strings - 100 cm <b>4065</b> Dust synthetic flat mop with strings - 110 cm <b>4066</b> Dust synthetic flat mop with strings - 130 cm <b>4067</b> Dust synthetic flat mop with strings - 160 cm <b>4072/S</b> Synthetic flat mop with strings (2x1 mt) for scissor mop	25 25 25 25 25 25 25 10	0,025/4,5 0,034/6,4 0,044/7 0,054/9,4 0,075/9,6 0,075/11 0,075/11,9 0,075/8,5



	Code	Description	Carton	Volume/Weight carton m <sup>3</sup> /kg
	70310	Dust microfibre flat mop with stripes and with velcro bottom 60x14 cm	50	
	71210	Dust microfibre white flat mop with velcro bottom - 60x11 cm	50	





# Frames and Wet Flat Mops

---

# Frames and Wet Flat Mops



**Material:** COTTON

**Advantages:** good cleaning and absorption capacity.

**Area of use:** most suitable for daily cleaning of lightly dirty to medium dirty surfaces.



Do not use softener



**Material:** SYNTHETIC, mix of polyester and viscose

**Advantages:** high cleaning performance, high absorption power, slow release of the cleaning solution, capability to retain the dirt.

**Area of use:** most suitable for daily cleaning of medium dirty surfaces.



Do not use softener



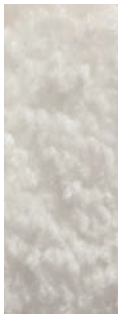

### Short haired white

**Material:** MICROFIBER 100% polyester

**Area of use:** the high capacity to remove the dirt makes it an ideal wet flat mop for maintenance cleaning in the sanitary environment.

#### Advantages:

- high sliding on treated and non-porous surfaces;
- it catches the dirt and leaves no marks;
- high capacity to remove the dirt;
- optimization of the washing cycles.



Do not use softener



### Short haired with stripes

**Material:** MICROFIBER

White yarn: 100% Polyester

Grey insert: 100% high tenacity polyamide

**Area of use:** suitable for all kind of surfaces and for all kind of dirt. The grey insert makes it ideal for heavy dirt.

#### Advantages:

- high sliding on all kind of floors;
- it catches the dirt and leaves no marks;
- high capacity to remove the heaviest dirt;
- optimization of the washing cycles;
- thanks to the grey inserts it is possible to remove the dirt in the grout lines of the tiles;
- ideal also for dusting operations on highly porous floors with grout lines.



Do not use softener

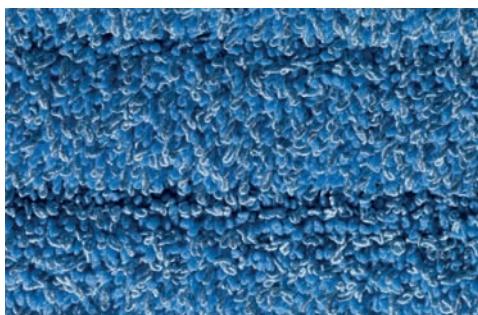

### Micro twisted yarn

**Material:** 80% Polyester and 20% Polyamide

**Area of use:** most suitable to clean polished surfaces (shopping malls, hotels hall) with a medium degree of dirt.

#### Advantages:

- high sliding on micro porous surfaces;
- it leaves no marks;
- high resistance to washing cycles;
- best performances on stoneware tiles.



Do not use softener

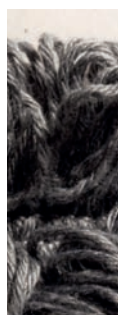

### Twisted yarn

**Material:** Microfiber mix (80% polyester and 20% polyamide) and synthetic (polyester and viscose)

**Area of use:** most suitable for all kind of floors in presence of grout lines and of medium/high dirt.





#### Advantages:







- it meets the highest cleaning standards;
- high sliding;
- capability to deeply catch the dirt;
- ideal for porous surfaces with wide grout lines;
- high capacity to catch and retain impurities such as dust and hair;
- slow release of the cleaning solution to get halos-free results;
- most suitable also for floors with a high degree of dirt.

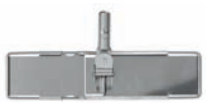



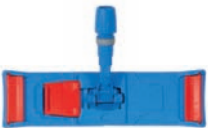

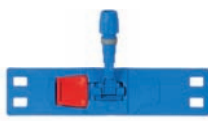

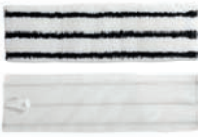

Do not use softener









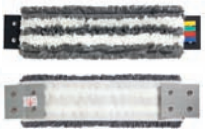

	Code	Description	Carton	Volume/Weight carton m <sup>3</sup> /kg
<b>Velcro Coupling</b>				
	<b>7033</b>	TRAPEZE plastic frame with velcro - 40 cm	25	0,043/6,5
	0480 0481	Velcro refill - short Velcro refill - long		
	<b>34710</b>	TRAPEZE aluminum frame with velcro - 40x10 cm	10	0,014/3,6
	<b>7081</b>	TRAPEZE stainless steel frame with velcro - 40 cm	25	0,045/13,5
	0480 0481	Velcro refill - short Velcro refill - long		
	<b>4086 SS</b>	TRAPEZE plastic frame with velcro - 60 cm	25	0,065/6
	0478 0479	Velcro refill - short Velcro refill - long		
<b>Pockets Coupling</b>				
	<b>7008</b>	Stainless steel folding frame - 40x10 cm		

	Code	Description	Carton	Volume/Weight carton m <sup>3</sup> /kg
	4075	Plastic frame with pedal - 40x10 cm	25	0,043/11,6
	4083/N 4080/N	Plastic frame with pedal - 40x13 cm Plastic frame with pedal - 50x13 cm	25	0,056/13,7 0,072/15,8
<b>Wings Coupling</b>				
	3710	CLACK frame with pedal - 40x11 cm	25	0,057/13,7
<b>Buttons Coupling</b>				
	3502	ELPAROLL plastic frame - 45x10 cm	25	0,055/11
	3506	ELPAROLL plastic frame with pedal - 45x10 cm	25	0,057/13,7
<b>TOUCH FREE SYSTEM</b>				
	7026	TOUCH FREE SYSTEM frame - 40x11 cm	1	





	Code	Description	Carton	Volume/Weight carton m <sup>3</sup> /kg
	<b>KIT7026</b>	Kit TOUCH FREE SYSTEM including frame (item no. 7026)	1	
	<b>Velcro Coupling</b>			
	<b>70300 Jolly</b>	Microfibre flat mop with stripes and with velcro bottom 44x13 cm	50	
	<b>7011</b>	Flat mop to dry with velcro bottom - 40 cm	50	
	<b>60670 Blue</b>	Microfibre flat mop with velcro bottom - 45x14 cm	50	0,037/7,5
	<b>70200 Soft</b>	Microfibre flat mop with velcro bottom - 45x15 cm	50	

	Code	Description	Carton	Volume/Weight carton m <sup>3</sup> /kg
	<b>71200 Soft FR</b>	Microfibre flat mop with velcro bottom - 44x11 cm	50	
	<b>7013</b>	Wet flat mop with velcro bottom - 45x14 cm	10	0,015/1,5
	<b>7039</b>	Microfibre flat mop with velcro bottom - 45x14 cm	10	0,015/1,5
<b>Disposables</b>				
	<b>60540</b>	Polypropylene and synthetic fibre disposable flat mop 45x10 cm	1 (250pcs)	0,035/2,6
<b>Wings Coupling</b>				
	<b>3720</b>	Wet flat mop with wings for CLACK frame - 40x11 cm	10	0,015/1,6

	Code	Description	Carton	Volume/Weight carton m <sup>3</sup> /kg
	3720/MF	Microfibre wet flat mop with wings for CLACK frame - 40x11 cm	10	0,015/1,6
	<b>Wings + Eyelets Coupling</b>			
	60664	Microfibre wet flat mop with wings and eyelets - 40 cm	50	0,037/7,5
	<b>Buttons Coupling</b>			
	3503	ELPAROLL wet flat mop with buttons - 45x10 cm	100	0,190/20,2
	3504	ELPAROLL microfibre wet flat mop with buttons - 45x10 cm	100	0,190/20,2
	3505	ELPAROLL wet flat mop with buttons - 45x10 cm	100	0,190/20,2

	Code	Description	Carton	Volume/Weight carton m <sup>3</sup> /kg
	3526	ELPAROLL abrasive flat mop with buttons - 45x11 cm	100	0,190/20
	<b>Pockets Coupling</b>			
	70302 Jolly	Microfiber wet flat mop with stripes and pockets - 40x11 cm	50	
	4076	Wet flat mop with pockets - 40x11 cm	25	0,029/4,4
	4076 MF	Microfibre flat mop with pockets - 40x11 cm	25	0,029/4,4
	4084 4081	Wet flat mop with pockets - 40x13 cm Wet flat mop with pockets - 50x13 cm	25	0,041/5,5 0,042/6,5



	Code	Description	Carton	Volume/Weight carton m <sup>3</sup> /kg
	7009	Wet flat mop EF with pockets - 40x10 cm	25	0,029/3,6
	7009 MF	Microfibre wet flat mop with pockets (for item no. 7008) - 40x10 cm	25	0,029/3,6
	70402 Soft	Microfibre white flat mop with pockets - 43x14 cm	50	
	60663	Microfibre flat mop with pockets - 40 cm	50	0,037/8
	<b>Pockets + Eyelets Coupling</b>			
	60660	Microfibre flat mop with pockets and eyeletes - 40 cm	50	0,037/6,9

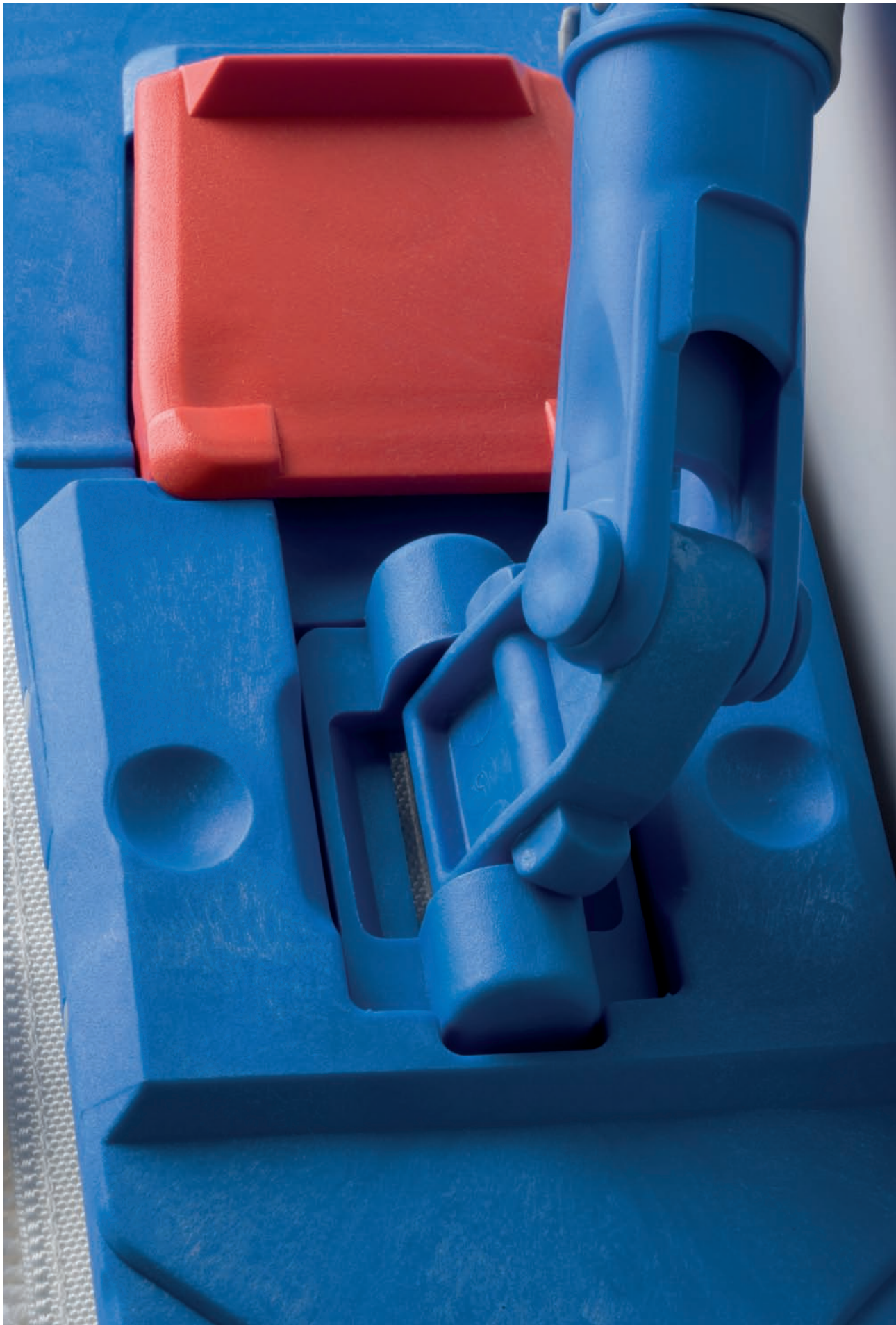



# Kentucky mops and mop holders

---

# Kentucky mops and mop holders

---







**Material:** TNT

**Advantages:** high absorption power.

**Area of use:** most suitable in food industry.



Do not use softener



**Material:** COTTON (Thin thread)

**Advantages:** great capability to retain the dirt.

**Area of use:** most suitable to clean all indoor surfaces



Do not use softener



**Material:** COTTON (Coarse thread)

**Advantages:** great capability to retain the dirt.

**Area of use:** most suitable to clean all indoor surfaces.



Do not use softener

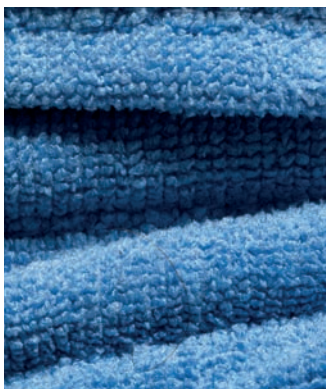

**Material:** MICROFIBER



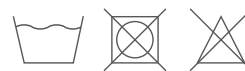

**Advantages:** effective in presence of heavy dirt.





**Area of use:** most suitable on all kind of indoor floors and in the food industry.





Do not use softener



	Code	Description	Carton	Volume/Weight carton m <sup>3</sup> /kg
	<b>Cotton</b>			
	<b>1068/250</b>	Cotton Kentucky mop with thin thread and screw - 250 g	50	0,072/14,5
	<b>1068/280</b>	Cotton Kentucky mop with thin thread and screw - 280 g		0,072/16
	<b>1068/300</b>	Cotton Kentucky mop with thin thread and screw - 300 g		0,072/17
		Semi professional use		
	<b>1069/200</b>	Cotton Kentucky mop with thick thread and screw - 200 g	50	0,060/12
	<b>1069/250</b>	Cotton Kentucky mop with thick thread and screw - 250 g		0,060/14,5
	<b>1069/300</b>	Cotton Kentucky mop with thick thread and screw - 300 g		0,072/17
	<b>1069/350</b>	Cotton Kentucky mop with thick thread and screw - 350 g		0,072/19,5
		Semi professional use		
	<b>4028/350</b>	Cotton Kentucky mop without band with hole - 350 g	50	0,090/19
	<b>4028/400</b>	Cotton Kentucky mop without band with hole - 400 g		0,090/21,5
	<b>4030/350</b>	Cotton Kentucky mop without band - 350 g	50	0,090/19
	<b>4030/400</b>	Cotton Kentucky mop without band - 400 g		0,090/21,5
	<b>4030/450</b>	Cotton Kentucky mop without band - 450 g		0,090/24
	<b>4030/500</b>	Cotton Kentucky mop without band - 500 g		0,105/26,5
	<b>4029/350</b>	Cotton Kentucky mop with band with hole - 350 g	50	0,090/19
	<b>4029/400</b>	Cotton Kentucky mop with band with hole - 400 g		0,090/21,5
	<b>4029/450</b>	Cotton Kentucky mop with band with hole - 450 g		0,090/24

Code	Description	Carton	Volume/Weight carton m <sup>3</sup> /kg
 <b>4031/350</b> <b>4031/400</b> <b>4031/450</b> <b>4031/500</b>	Cotton Kentucky mop with band - 350 g Cotton Kentucky mop with band - 400 g Cotton Kentucky mop with band - 450 g Cotton Kentucky mop with band - 500 g	50	0,090/19 0,090/21,5 0,090/24 0,105/26,5
<b>TNT</b>			
 <b>1080</b>	Highly absorbent woven non-woven fabric Kentucky mop with screw (100% viscose) - 210 g	50	0,100/12
 <b>1080/180</b>	Highly absorbent woven non-woven fabric Kentucky mop with screw (polyestere and viscose) - 180 g	50	
 <b>4032/N</b>	Highly absorbent woven non-woven fabric Kentucky mop (100% viscose) - 230 g	50	0,135/15,5
<b>Microfibre</b>			
 <b>60653</b>	Blue microfibre Kentucky mop with band - 250 g	50	0,068/14,7

Code	Description	Carton	Volume/Weight carton m <sup>3</sup> /kg
 4010 ● 4010/A ●	Plastic mop-holder	100	0,06/10,4
 4001	Set composed of: Kentucky mop, mop-holder and handle	1	





# Handles and Telescopic Poles

---



# Handles and Telescopic Poles



**Ergonomic, light and handy.** Handles and telescopic poles with different dimensions and diameters to meet any kind of need.



**NEW**

**SPRAY CLEAN.** Water reservoir handle for washing and disinfection of floors up to 25 sq mtrs.













**Water reservoir handle.** Equipped with three holes to deliver water or water and detergent.









**Maximum practicality.** Thanks to the special knob, the water is delivered directly from the handle.



	Code	Description	Carton	Volume/Weight carton m <sup>3</sup> /kg
	4025	Aluminum handle Ø 24 mm, 145 cm, with hole (1 pc)	25	0,048/10,3
	4421	Aluminum handle Ø 23,5 mm, 140 cm, with hole (1 pc)	25	0,048/10
	4422	Aluminum handle Ø 23,5 mm, 140 cm, with screw (1 pc)	25	0,048/10
	4021	Aluminum handle Ø 23 mm, 140 cm, with hole (2 pcs)	50	0,070/15
	4426	Telescopic aluminum handle 160 cm, with hole (1 pc)	50	0,1/17

	Code	Description	Carton	Volume/Weight carton m <sup>3</sup> /kg
	4019	Wooden handle Ø 24 mm, 150 cm, with hole and screw (1 pc)	50	0,048/24
	1058	Aluminum handle Ø 22 mm, 130 cm, with screw (1 pc)	20	0,030/8
	4016 4016/F	Telescopic handle 150 cm, with hole (1 pc) Telescopic handle 150 cm, with screw (1 pc)	10	0,018/7,2
	4020	Chromed handle Ø 22 mm, 145 cm, with hole (2 pcs)	25	0,033/16,5
	4089	SPRAY CLEAN water reservoir handle 500 ml	25	

	Code	Description	Carton	Volume/Weight carton m <sup>3</sup> /kg
	4089/1	Water reservoir handle 500 ml complete with TRAPEZE plastic frame	1	
	4013	End cone with screw. Suitable for handle 4016		
	4022	Threaded joint for handle Ø 22 mm. Adaptable to the handle item no. 4020		
	4024	Threaded joint for handle Ø 24 mm. Adaptable to the handles item no. 4025-4421		
<b>Telescopic pole</b>				
	32125	Telescopic pole - 2x1,25 mt		0,026/6,2
	32200	Telescopic pole - 2x2 mt		0,041/9,8
	33100	Telescopic pole - 3x1 mt		0,026/10,4
	33150	Telescopic pole - 3x1,50 mt	10	0,035/14,8
	33200	Telescopic pole - 3x2 mt		0,042/18,5
	33201	Telescopic pole - 3x3 mt		0,060/27,2
33203	Telescopic pole - 4+4+3 mt		0,100/35,5	
	33398	Cranked joint (aluminum) for telescopic pole	10	

Code	Description	Carton	Volume/Weight carton m <sup>3</sup> /kg
 33402	End cone with screw	10	





# Window Cleaning Line and Floor Squeegees

---

# Window Cleaning Line and Floor Squeegees

---





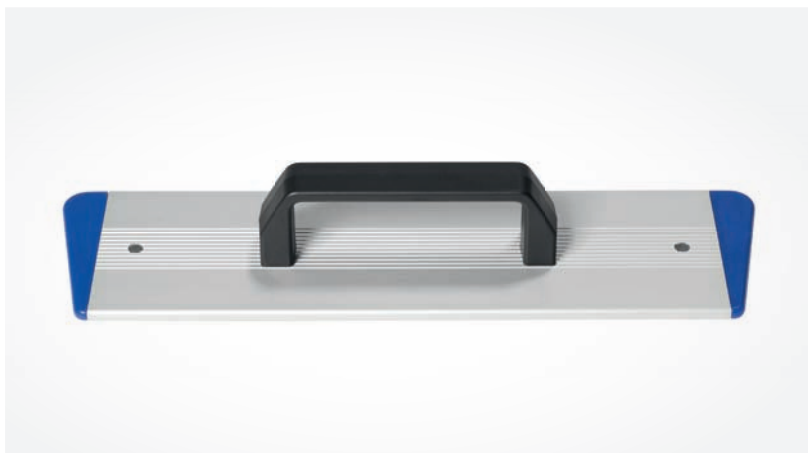

**Domino System.** A tool that helps the operator to clean efficiently vertical surfaces (windows, walls, doors) as well as flat surfaces (desks, window sills...). This frame is available in two versions: swiveling to be used with the telescopic poles and with handle for manual use.







**Handle.** The handle, made of polypropylene, is ergonomic and the two velcro grips on the bottom can be replaced.



















	Code	Description	Carton	Volume/Weight carton m <sup>3</sup> /kg
	<b>CLEANO</b>			
	34800 34803	CLEANO telescopic pole - 2x70 cm CLEANO telescopic pole - 2x150 cm		0,019/1,9 0,032/2,6
	34802	Ultramicrofibre cloth for CLEANO - 10x26 cm	20	0,005/0,7
	34801	Nylon bag for CLEANO		
<b>DOMINO SYSTEM</b>				
	34701	DOMINO SYSTEM aluminum frame with handle and two replaceable velcro refill - 28x8 cm	10	0,014/ 2,4
	34700	DOMINO SYSTEM aluminum frame with two replaceable velcro refill and articulated joint for telescopic pole - 28x8 cm	10	0,014/ 2,8





	Code	Description	Carton	Volume/Weight carton m <sup>3</sup> /kg
	34702	Ultramicrofibre cloth for DOMINO SYSTEM - 30x10 cm	20	0,005/0,9
	<b>Window Squeegees</b>			
	30525	Complete inox window squeegee - 25 cm	10	0,005/1,8
	30530	Complete inox window squeegee - 30 cm		0,005/1,9
	30535	Complete inox window squeegee - 35 cm		0,005/2
	30540	Complete inox window squeegee - 40 cm		0,005/2,1
	30545	Complete inox window squeegee - 45 cm		0,005/2,2
	30550	Complete inox window squeegee - 50 cm		0,006/2,4
	30555	Complete inox window squeegee - 55 cm	0,006/2,6	
	30580	Handle for inox window squeegee	10	0,005/1,1
	30225	Complete Technolite window squeegee - 25 cm	10	0,006/1,6
	30235	Complete Technolite window squeegee - 35 cm		0,006/1,9
	30245	Complete Technolite window squeegee - 45 cm		0,006/2,1
	30255	Complete Technolite window squeegee - 55 cm		0,006/2,4
	30625	Inox channel with rubber - 25 cm	25	0,003/1,5
	30630	Inox channel with rubber - 30 cm		0,005/1,9
	30635	Inox channel with rubber - 35 cm		0,005/2,3
	30640	Inox channel with rubber - 40 cm		0,005/2,5
	30645	Inox channel with rubber - 45 cm		0,005/2,9
	30650	Inox channel with rubber - 50 cm		0,006/ 3,1
	30655	Inox channel with rubber - 55 cm	0,006/ 3,5	









	Code	Description	Carton	Volume/Weight carton m <sup>3</sup> /kg
	30692	Replacement rubber - 92 cm	100	0,054/6
	30695	Replacement rubber - 71 cm		0,054/4,6
	30725	Complete plastic window squeegee - 25 cm	10	0,007/0,87
	30730	Complete plastic window squeegee - 30 cm		0,007/ 0,96
	30735	Complete plastic window squeegee - 35 cm		0,007/1
	30740	Complete plastic window squeegee - 40 cm		0,007/1,1
	30745	Complete plastic window squeegee - 45 cm		0,007/1,2
<b>Window Washers</b>				
	33425	Complete window washer - 25 cm	100	0,151/12,4
	33435	Complete window washer - 35 cm	100	0,151/16
	33445	Complete window washer - 45 cm	50	0,151/10,2
	33426	Replacement sleeve - 25 cm	200	0,100/9
	33436	Replacement sleeve - 35 cm	200	0,100/10,1
	33446	Replacement sleeve - 45 cm	150	0,150/11,1
	33427	Plastic support for window washer - 25 cm	100	0,071/8,5
	33437	Plastic support for window washer - 35 cm	100	0,100/10,1
	33447	Plastic support for window washer - 45 cm	50	0,055/6,5

	Code	Description	Carton	Volume/Weight carton m <sup>3</sup> /kg
	33412	Complete window washer with abrasive strip - 25 cm	100	0,160/16,2
	33416	Complete window washer with abrasive strip - 35 cm	100	0,160/20,7
	33420	Complete window washer with abrasive strip - 45 cm	50	0,150/12,6
	33413	Replacement sleeve with abrasive strip - 25 cm	200	0,100/12
	33417	Replacement sleeve with abrasive strip - 35 cm	200	0,150/14
	33421	Replacement sleeve with abrasive strip - 45 cm	150	0,150/13
	33535	Complete microfibre window washer - 35 cm	100	0,151/16
	33545	Complete microfibre window washer - 45 cm	50	0,151/10,2
	33536	Microfibre replacement sleeve - 35 cm	200	0,150/10
	33546	Microfibre replacement sleeve - 45 cm	150	0,150/11
<b>Swivelling window squeegees</b>				
	31080	Swivelling handle for window squeegee	10	0,007/1,9

	Code	Description	Carton	Volume/Weight carton m <sup>3</sup> /kg
	<b>31025</b>	Complete swivelling window squeegee - 25 cm	10	0,007/2,5
	<b>31030</b>	Complete swivelling window squeegee - 30 cm	10	0,007/2,7
	<b>31035</b>	Complete swivelling window squeegee - 35 cm	10	0,007/2,9
	<b>31040</b>	Complete swivelling window squeegee - 40 cm	5	0,05/1,5
	<b>31045</b>	Complete swivelling window squeegee - 45 cm	5	0,05/1,6
	<b>30925</b>	Brass channel with rubber - 25 cm		0,05/2
	<b>30930</b>	Brass channel with rubber - 30 cm		0,05/2,3
	<b>30935</b>	Brass channel with rubber - 35 cm	25	0,05/2,9
	<b>30940</b>	Brass channel with rubber - 40 cm		0,05/3,3
	<b>30945</b>	Brass channel with rubber - 45 cm		0,05/3,6
<b>Swivelling window washers</b>				
	<b>33423</b>	Complete swivelling window washer - 25 cm	100	0,150/18,5
	<b>33433</b>	Complete swivelling window washer - 35 cm	100	0,150/23,1
	<b>33443</b>	Complete swivelling window washer - 45 cm	50	0,150/15
	<b>33428</b>	Swivelling window washer handle - 25 cm		0,050/7
	<b>33438</b>	Swivelling window washer handle - 35 cm	50	0,050/9
	<b>33448</b>	Swivelling window washer handle - 45 cm		0,060/11
<b>Scrapers</b>				
	<b>34010</b>	Pocket scraper - without blade	12	

	Code	Description	Carton	Volume/Weight carton m <sup>3</sup> /kg
	34011	Blade for pocket scraper	100	
	34000	Scraper with plastic handle	25	0,018/3,2
	34025	Scraper with handle - 25 cm	25	0,018/4,2
	34120	Scraper with handle - 120 cm	10	0,027/3,3
	34150	Replacement blade for scraper	200	
	34200	10 blade dispenser for scraper	10	

	Code	Description	Carton	Volume/Weight carton m <sup>3</sup> /kg
	33500	CLIP scraper with 10 blades	50	
	33501	Replacement blade for CLIP scraper	300	
<b>Miscellaneous</b>				
	33480	Cobweb collector	10	0,110/2,2
	2270 A ● 2270 R ●	13 Lt rect. bucket	25	0,150/23,5
	7030 B ● 7030 R ●	22 Lt rect. bucket	6	0,120/8,7

Code	Description	Carton	Volume/Weight carton m <sup>3</sup> /kg
<b>Floor squeegees</b>			
	<b>30345</b> Metal floor squeegee - 45 cm	72	0,087/26
	<b>30355</b> Metal floor squeegee - 55 cm	72	0,128/29
	<b>30375</b> Metal floor squeegee - 75 cm	36	0,107/20,5
	<b>30435</b> Plastic floor squeegee - 35 cm	30	0,073/6,8
	<b>30445</b> Plastic floor squeegee - 45 cm		0,092/9
	<b>30455</b> Plastic floor squeegee - 55 cm		0,109/9,4
	<b>30475</b> Plastic floor squeegee - 75 cm		0,137/11,9





# Various Professional Products

---

<b>Pads and Scrubbers</b>	<b>242</b>
<b>Microfiber cloths</b>	<b>244</b>
<b>Sign Panels</b>	<b>247</b>
<b>Dustpans</b>	<b>248</b>
<b>Dusters</b>	<b>249</b>

# Various Professional Products



## BLUE

**Area of use:** Tables / Desks / Cupboards / Glasses



Do not use softener



## GREEN

**Area of use:** Kitchens / Canteens / Bars



Do not use softener

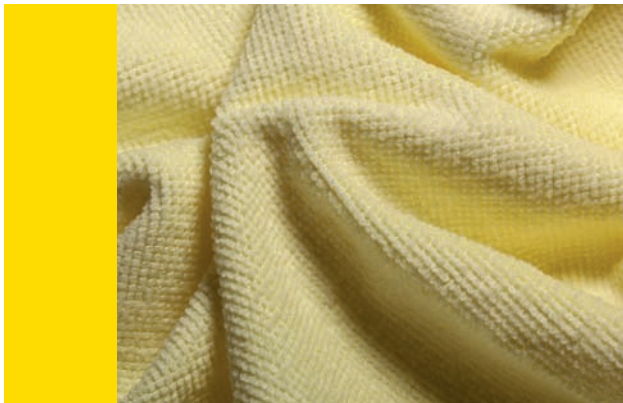

## YELLOW

**Area of use:** Sink / Shower / Bathtub



Do not use softener

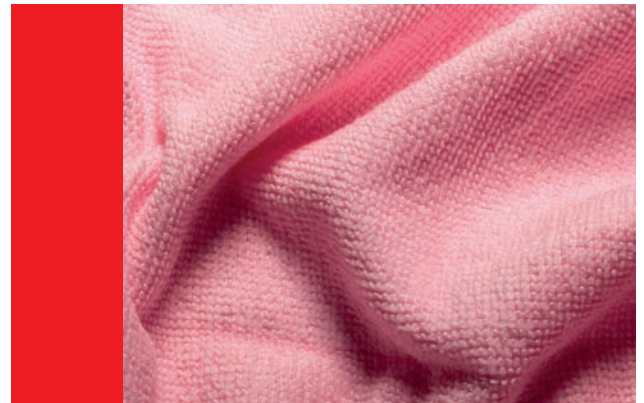

## RED

**Area of use:** Bidet / WC



Do not use softener

**Microfiber cloths:** extremely absorbing, they grant high performances, retaining dirt and bacteria and reducing the working times by 25-30%.

**Yarn composition:**





-70% polyester: resistance to wear, abrasion and machine washing. Capacity to remove and to retain the dirt.





-30% polyamide: high mechanical power. Capability to retain the dirt.

**Weight:** 200-300 g/sq mtr







**Professional duster.** Most suitable to clean high and vertical surfaces.





	Code	Description	Carton	Volume/Weight carton m <sup>3</sup> /kg
	<b>TOUCH FREE SYSTEM</b>			
	KIT7027	Kit TOUCH FREE SYSTEM (set of clamps for 22 lt bucket)	1	
	KIT7026	Kit TOUCH FREE SYSTEM including frame (item no. 7026)	1	
	<b>Pads and Scrubbers</b>			
	4090	Hand scrubber	15	0,014/3,1
	4091	Upright scrubber	12	0,014/2,4
	4078/BI ○ 4078/N ● 4078/R ● 4078/V ●	Pad - 12x25 cm	12	0,010/0,5





	Code	Description	Carton	Volume/Weight carton m <sup>3</sup> /kg
	4079/BI ○ 4079/N ● 4079/R ● 4079/V ●	Handle with pad - 15x10 cm	5	0,006/0,7
<b>Applying Wax</b>				
	33601	Wax-spreading tool complete	10	0,054/10,84
	33602	Wax-spreading sleeve	10	
	7030 R ●	22 Lt rect. bucket	6	0,120/8,7
	7029	Set of castors (4) for 22 Lt rect. bucket		











	Code	Description	Carton	Volume/Weight carton m <sup>3</sup> /kg
	34600	Stainless steel grid	5	0,006/0,7
	4751 4752 4758 4730	Wax applicator JUMBO-WAX 1,7 lt with frame 40 cm (item no. 7033) Wax applicator JUMBO-WAX 1,7 lt with frame 60 cm (item no. 4086 SS) Wax tank 2,5 lt Handle holder	1 1 1 1	0,037/1,7 0,037/1,7
		(While stock last)		
	<b>Disinfectant Distributor</b>			
	4088	Disinfectant distributor, equipped with rubber dust frame (item no.4087), 4 bottles (item no. 4110)	1	0,046/3,2
	4170/B	Cloth for disinfectant distributor (item no. 4088)	20	
	<b>Microfiber cloths</b>			
	3651 ● 3652 ● 3653 ● 3654 ●	Fabric microfibre cloth 300 g/m <sup>2</sup> - 40x40 cm	5x40	0,07/10

	Code	Description	Carton	Volume/Weight carton m <sup>3</sup> /kg
	3655 ●●●●	4 pcs Set - Fabric microfibre cloth 200 g/m <sup>2</sup> - 40x40 cm	Sets 50	0,06/8
	2060 B ● 2060 R ● 2060 J ● 2060 V ●	One-color fabric microfibre cloth 200 g/m <sup>2</sup> - 40x40 cm	5x20	
<b>Nippers</b>				
	34540 34570 34599	Nipper - 40 cm Nipper - 70 cm Nipper - 100 cm	10	0,021/2,1 0,036/3 0,045/3,9
<b>Miscellaneous</b>				
	22065 22050 22051 22052 22053 22054	Complete belt (4 pockets) Belt only Bottle pocket (blue) Bottle pocket (red) Tools pocket Mobile pocket  (While stock last)		
	1071	FAST water hose		

	Code	Description	Carton	Volume/Weight carton m <sup>3</sup> /kg
	GIPSY A/G ●●	Multipurpose set GIPSY equipped with 5 removable dividing walls and 4 removable handle holders	2	0,100/8
	2306 ●	Window bucket for GIPSY 47x12x30h cm		
	2310	Strap for GIPSY		
	21075 Microroll System	"Rapid" system for the preparation of strongly squeezed microfibre cloths.  Composed by: 1 MICROROLL wringer 1x22 lt bucket (grey) 2x6 lt buckets (blue, red)		
	80077	Bottle holder with bottles divider		

	Code	Description	Carton	Volume/Weight carton m <sup>3</sup> /kg
<b>Sign Panels</b>				
	4260/2	Sign panel equipped with 2 sign-disks (SLIPPERY FLOOR / WET FLOOR)	10	0,100/13,5
	4263/7	Sign-disk (CAUTION/WET FLOOR)		
	4263/8	Sign-disk (CLEANING IN PROGRESS)		
	4264	Sign-disk Blue (ARROW)  (While stock last)		
	4265	Sign-disk Red (NO ENTRY)		

Code	Description	Carton	Volume/Weight carton m <sup>3</sup> /kg
<b>Dustpans and dusters</b>			
	<b>4039</b> Maxi dustpan  (While stock last)	24	0,043/3
	<b>4040 SET</b> Dustpan with handle, broom and hook (set)	8	0,075/7,4
	<b>4350</b> Large dustpan with broom and handle, vinyl broom and telescopic broom handle - 130 cm	8	0,090/13
	<b>4380</b> Professional microfibre duster 60 cm	12	0,027/3,5
	<b>4381</b> Duster frame	12	0,027/2,8

Code	Description	Carton	Volume/Weight carton m <sup>3</sup> /kg
	<b>4382</b> Microfibre replacement sleeve	36	0,052/2,4
	<b>4037</b> Ostrich feather duster	30	0,069/3
	<b>4038</b> Woollen duster	100	0,120/10
	<b>4357</b> Synthetic duster	100	0,120/10





# Health Line

---

DMX - Pre

254

---

# Health Line

---



**VELBOX sweeping system.** It is equipped with a system that blocks the disposable cloths during the transport.



**Easiness.** The VELBOX system allows an easy and ergonomic loading of the disposable cloths.



**Ergonomics.** The VELBOX system allows the fixing of the disposable cloths to the frame avoiding the bending of the operator's back.



**Drawers.** Can be equipped with hermetic covers for pre-impregnation and can be easily stacked-up.



**Structured space.** The SPACE version has been studied for those who require further loading space.



**Everything ready to hand.** The Tecno-Shower dispenser can be easily stored in the trolley.



**Safety.** Equipped with a single metal lock to block all the drawers and with a pivoting basket to store small components.



Code	Description	Color
------	-------------	-------

**DMX COMPACT Multifunctional enclosed plastic trolley 900.2**

21001AB/DMX	1 IDEA/AB base equipped with 4 outdoor soft castors Ø 125 mm (item no. 21027)	●
21003 B	1 Base end	●
25050	1 DMX vertical frame without lock - 2 drawers	●
25052	1 DMX vertical frame with lock - 2 drawers	●
23020 G	1x4 lt bucket	●
23020 R	1x4 lt bucket	●
2250 BA	1x6 lt bucket	●
25066 A	1x30 lt drawer for DMX	●
25066/P	1x30 lt drawer with bumpers	●
25060	1 Lid for drawers	●
23024/N	1 Plastic basket for buckets without handle holder and hooks for MX/DMX	●
23005 BA	1 Bag-holder equipped with 4 handle holders, lid with document holder and sliding device for MX/DMX	●
25064	2 DMX small keys housings	●
23003/1	1 Upper tray for buckets for MX/DMX	●
KITDMXPRE/A	1 Assembling kit for DMX COMPACT 900	●

Code	Description	Color
------	-------------	-------

**DMX COMPACT Multifunctional enclosed plastic trolley 900.3**

21001AB/DMX	1 IDEA/AB base equipped with 4 outdoor soft castors Ø 125 mm (item no. 21027)	●
21003 B	1 Base end	●
25051	1 DMX vertical frame without lock - 3 drawers	●
25053	1 DMX vertical frame with lock - 3 drawers	●
23020 G	1x4 lt bucket	●
23020 R	1x4 lt bucket	●
2250 BA	1x6 lt bucket	●
25065 A	1x20 lt drawer for DMX	●
25065/P	2x20 lt drawers with bumpers	●
25060	2 Lids for drawers	●
23024/N	1 Plastic basket for buckets without handle holder and hooks for MX/DMX	●
23005 BA	1 Bag-holder equipped with 4 handle holders, lid with document holder and sliding device for MX/DMX	●
25064	2 DMX small keys housings	●
23003/1	1 Upper tray for buckets for MX/DMX	●
KITDMXPRE/A	1 Assembling kit for DMX COMPACT 900	●

83x56x105h cm | 1 Pc/carton | 25,1 Kg | 0,390 m<sup>3</sup>

83x56x105h cm | 1 Pc/carton | 25,9 Kg | 0,390 m<sup>3</sup>





Code	Description	Color
------	-------------	-------

**DMX COMPACT Multifunctional enclosed plastic trolley 1000.2**

21001AB/COMPACT	1 IDEA/AB base equipped with 4 outdoor soft castors Ø 125 mm (item no. 21027) and with door stop	●
21003 B	1 Base end	●
25050	1 DMX vertical frame without lock - 2 drawers	●
25052	1 DMX vertical frame with lock - 2 drawers	●
23011N	1 Left door for MX/DMX	○
23012N	1 Right door for MX/DMX	○
23020 G	1x4 lt bucket	●
23020 R	1x4 lt bucket	●
2250 BA	1x6 lt bucket	●
25066 A	1x30 lt drawer for DMX	●
25066/P	1x30 lt drawer with bumpers	●
25060	1 Lid for drawers	●
23024/N	1 Plastic basket for buckets without handle holder and hooks for MX/DMX	●
23005 BA	1 Bag-holder equipped with 4 handle holders, lid with document holder and sliding device for MX/DMX	●
25064	2 DMX small keys housings	●
23003/1	1 Upper tray for buckets for MX/DMX	●
KITDMXPRE/B	1 Assembling kit for DMX COMPACT 1000-4000	●

Code	Description	Color
------	-------------	-------

**DMX COMPACT Multifunctional enclosed plastic trolley 1000.3**

21001AB/COMPACT	1 IDEA/AB base equipped with 4 outdoor soft castors Ø 125 mm (item no. 21027) and with door stop	●
21003 B	1 Base end	●
25051	1 DMX vertical frame without lock - 3 drawers	●
25053	1 DMX vertical frame with lock - 3 drawers	●
23011N	1 Left door for MX/DMX	○
23012N	1 Right door for MX/DMX	○
23020 G	1x4 lt bucket	●
23020 R	1x4 lt bucket	●
2250 BA	1x6 lt bucket	●
25065 A	1x20 lt drawer for DMX	●
25065/P	2x20 lt drawers with bumpers	●
25060	2 Lids for drawers	●
23024/N	1 Plastic basket for buckets without handle holder and hooks for MX/DMX	●
23005 BA	1 Bag-holder equipped with 4 handle holders, lid with document holder and sliding device for MX/DMX	●
25064	2 DMX small keys housings	●
23003/1	1 Upper tray for buckets for MX/DMX	●
KITDMXPRE/B	1 Assembling kit for DMX COMPACT 1000-4000	●

 83x56x105h cm |  1 Pc/carton 29,7 Kg 0,390 m<sup>3</sup>

 83x56x105h cm |  1 Pc/carton 30,5 Kg 0,390 m<sup>3</sup>



Code	Description	Color
------	-------------	-------

**DMX COMPACT Multifunctional enclosed plastic trolley 2000.2**

21001AB/COMPACT	1 IDEA/AB base equipped with 4 outdoor soft castors Ø 125 mm (item no. 21027) and with door stop	●
21003 B	1 Base end	●
25050	1 DMX vertical fram without lock - 2 drawers	●
25052	1 DMX vertical frame with lock - 2 drawers	●
23011N	1 Left door for MX/DMX	○
23012N	1 Right door for MX/DMX	○
23020 B	2x4 lt buckets	●
23020 G	1x4 lt bucket	●
23020 R	1x4 lt bucket	●
2250 BA	1x6 lt bucket	●
25066 A	1x30 lt drawer for DMX	●
25066/P	1x30 lt drawer with bumpers	●
25060	1 Lid for drawers	●
23023 KIT	1 Kit rilsan basket for 4 lt buckets	●
23024/N	1 Plastic basket for buckets without handle holder and hooks for MX/DMX	●
23005 BA	1 Bag-holder equipped with 4 handle holders, lid with document holder and sliding device for MX/DMX	●
24057 KIT	1 Kit VELBOX support	●
VELBOX	1 Dispenser for pre-impregnated cloths (VELBOX)	●
25064	2 DMX small keys housings	●
23003/1	1 Upper tray for buckets for MX/DMX	●
KITDMXPRE/C	1 Assembling kit for DMX COMPACT 2000-3000	●

Code	Description	Color
------	-------------	-------

**DMX COMPACT Multifunctional enclosed plastic trolley 2000.3**

21001AB/COMPACT	1 IDEA/AB base equipped with 4 outdoor soft castors Ø 125 mm (item no. 21027) and with door stop	●
21003 B	1 Base end	●
25051	1 DMX vertical frame without lock - 3 drawers	●
25053	1 DMX vertical frame with lock - 3 drawers	●
23011N	1 Left door for MX/DMX	○
23012N	1 Right door for MX/DMX	○
23020 B	2x4 lt buckets	●
23020 G	1x4 lt bucket	●
23020 R	1x4 lt bucket	●
2250 BA	1x6 lt bucket	●
25065 A	1x20 lt drawer for DMX	●
25065/P	2x20 lt drawers with bumpers	●
25060	2 Lids for drawers	●
23023 KIT	1 Kit rilsan basket for 4 lt buckets	●
23024/N	1 Plastic basket for buckets without handle holder and hooks for MX/DMX	●
23005 BA	1 Bag-holder equipped with 4 handle holders, lid with document holder and sliding device for MX/DMX	●
24057 KIT	1 Kit VELBOX support	●
VELBOX	1 Dispenser for pre-impregnated cloths (VELBOX)	●
25064	2 DMX small keys housings	●
23003/1	1 Upper tray for buckets for MX/DMX	●
KITDMXPRE/C	1 Assembling kit for DMX COMPACT 2000-3000	●

 105x56x105h cm |  1 Pc/carton 32,3 Kg 0,390 m<sup>3</sup>

 105x56x105h cm |  1 Pc/carton 33,2 Kg 0,390 m<sup>3</sup>



Code	Description	Color
------	-------------	-------

**DMX COMPACT Multifunctional enclosed plastic trolley 3000.2**

21001AB/COMPACT	1 IDEA/AB base equipped with 4 outdoor soft castors Ø 125 mm (item no. 21027) and with door stop	●
21003 B	1 Base end	●
25050	1 DMX vertical frame without lock - 2 drawers	●
25052	1 DMX vertical frame with lock - 2 drawers	●
23011N	1 Left door for MX/DMX	○
23012N	1 Right door for MX/DMX	○
23020 B	4x4 lt buckets	●
23020 G	1x4 lt bucket	●
23020 R	1x4 lt bucket	●
2250 BA	1x6 lt bucket	●
25066 A	1x30 lt drawer for DMX	●
25066/P	1x30 lt drawer with bumpers	●
25060	1 Lid for drawers	●
23023 KIT	2 Kit rilsan baskets for 4 lt buckets	●
23024/N	1 Plastic basket for buckets without handle holder and hooks for MX/DMX	●
23005 BA	1 Bag-holder equipped with 4 handle holders, lid with document holder and sliding device for MX/DMX	●
25064	2 DMX small keys housings	●
23003/1	1 Upper tray for buckets for MX/DMX	●
KITDMXPRE/C	1 Assembling kit for DMX COMPACT 2000-3000	●

Code	Description	Color
------	-------------	-------

**DMX COMPACT Multifunctional enclosed plastic trolley 3000.3**

21001AB/COMPACT	1 IDEA/AB base equipped with 4 outdoor soft castors Ø 125 mm (item no. 21027) and with door stop	●
21003 B	1 Base end	●
25051	1 DMX vertical frame without lock - 3 drawers	●
25053	1 DMX vertical frame with lock - 3 drawers	●
23011N	1 Left door for MX/DMX	○
23012N	1 Right door for MX/DMX	○
23020 B	4x4 lt buckets	●
23020 G	1x4 lt bucket	●
23020 R	1x4 lt bucket	●
2250 BA	1x6 lt bucket	●
25065 A	1x20 lt drawer for DMX	●
25065/P	2x20 lt drawers with bumpers	●
25060	2 Lids for drawers	●
23023 KIT	2 Kit rilsan baskets for 4 lt buckets	●
23024/N	1 Plastic basket for buckets without handle holder and hooks for MX/DMX	●
23005 BA	1 Bag-holder equipped with 4 handle holders, lid with document holder and sliding device for MX/DMX	●
25064	2 DMX small keys housings	●
23003/1	1 Upper tray for buckets for MX/DMX	●
KITDMXPRE/C	1 Assembling kit for DMX COMPACT 2000-3000	●

 105x56x105h cm |  1 Pc/carton 32,2 Kg 0,390 m<sup>3</sup>

 105x56x105h cm |  1 Pc/carton 33,1 Kg 0,390 m<sup>3</sup>





Code	Description	Color
------	-------------	-------

**DMX COMPACT Multifunctional enclosed plastic trolley 4000.2**

21001AB/COMPACT	1 IDEA/AB base equipped with 4 outdoor soft castors Ø 125 mm (item no. 21027) and with door stop	●
21003 B	1 Base end	●
25050	1 DMX vertical frame without lock - 2 drawers	●
25052	1 DMX vertical frame with lock - 2 drawers	●
23011N	1 Left door for MX/DMX	○
23012N	1 Right door for MX/DMX	○
23020 G	1x4 lt bucket	●
23020 R	1x4 lt bucket	●
2250 BA	1x6 lt bucket	●
25066 A	1x30 lt drawer for DMX	●
25065/P	1x20 lt drawer with bumpers	●
25066/P	1x30 lt drawer with bumpers	●
25060	1 Lid for drawers	●
23024/N	1 Plastic basket for buckets without handle holder and hooks for MX/DMX	●
23005 BA	1 Bag-holder equipped with 4 handle holders, lid with document holder and sliding device for MX/DMX	●
25064	2 DMX small keys housings	●
23003/1	1 Upper tray for buckets for MX/DMX	●
23046	1 Rilsan basket for 22 lt bucket for MX/DMX	●
KITDMXPRE/B	1 Assembling kit for DMX COMPACT 1000-4000	●

Code	Description	Color
------	-------------	-------

**DMX COMPACT Multifunctional enclosed plastic trolley 4000.3**

21001AB/COMPACT	1 IDEA/AB base equipped with 4 outdoor soft castors Ø 125 mm (item no. 21027) and with door stop	●
21003 B	1 Base end	●
25051	1 DMX vertical frame without lock - 3 drawers	●
25053	1 DMX vertical frame with lock - 3 drawers	●
23011N	1 Left door for MX/DMX	○
23012N	1 Right door for MX/DMX	○
23020 G	1x4 lt bucket	●
23020 R	1x4 lt bucket	●
2250 BA	1x6 lt bucket	●
25065 A	1x20 lt drawer for DMX	●
25065/P	3x20 lt drawers with bumpers	●
25060	2 Lids for drawers	●
23024/N	1 Plastic basket for buckets without handle holder and hooks for MX/DMX	●
23005 BA	1 Bag-holder equipped with 4 handle holders, lid with document holder and sliding device for MX/DMX	●
25064	2 DMX small keys housings	●
23003/1	1 Upper tray for buckets for MX/DMX	●
23046	1 Rilsan basket for 22 lt bucket for MX/DMX	●
KITDMXPRE/B	1 Assembling kit for DMX COMPACT 1000-4000	●

83x56x105h cm | 1 Pc/carton | 31,1 Kg | 0,390 m<sup>3</sup>

83x56x105h cm | 1 Pc/carton | 31,9 Kg | 0,390 m<sup>3</sup>



Code	Description	Color
------	-------------	-------

**DMX COMPACT Multifunctional enclosed plastic trolley 5000.2**

21001AB/COMPACT	1 IDEA/AB base equipped with 4 outdoor soft castors Ø 125 mm (item no. 21027) and with door stop	●
21003 B	1 Base end	●
25050	1 DMX vertical frame without lock - 2 drawers	●
25052	1 DMX vertical frame with lock - 2 drawers	●
23011N	1 Left door for MX/DMX	○
23012N	1 Right door for MX/DMX	○
23020 G	1x4 lt bucket	●
23020 R	1x4 lt bucket	●
2250 BA	1x6 lt bucket	●
25066 A	1x30 lt drawer for DMX	●
25065/P	1x20 lt drawer with bumpers	●
25066/P	1x30 lt drawer with bumpers	●
25060	2 Lids for drawers	●
23024/N	1 Plastic basket for buckets without handle holder and hooks for MX/DMX	●
23005 BA	1 Bag-holder equipped with 4 handle holders, lid with document holder and sliding device for MX/DMX	●
23000 KIT	1 Kit rilsan tray holder extension for DMX	●
7079	1 Rilsan support for dispenser Tecno-Shower	●
7080	1 Tecno-Shower dispenser	●
24057 KIT	1 Kit VELBOX support - rilsan	●
VELBOX	1 Dispenser for pre-impregnated cloths (VELBOX)	●
25064	2 DMX small keys housings	●
23003/1	1 Upper tray for buckets for MX/DMX	●
23046	1 Rilsan basket for 22 lt bucket for MX/DMX	●
KITDMXPRE/D	1 Assembling kit for DMX COMPACT 5000	●

Code	Description	Color
------	-------------	-------

**DMX COMPACT Multifunctional enclosed plastic trolley 5000.3**

21001AB/COMPACT	1 IDEA/AB base equipped with 4 outdoor soft castors Ø 125 mm (item no. 21027) and with door stop	●
21003 B	1 Base end	●
25051	1 DMX vertical frame without lock - 3 drawers	●
25053	1 DMX vertical frame with lock - 3 drawers	●
23011N	1 Left door for MX/DMX	○
23012N	1 Right door for MX/DMX	○
23020 G	1x4 lt bucket	●
23020 R	1x4 lt bucket	●
2250 BA	1x6 lt bucket	●
25065 A	1x20 lt drawer for DMX	●
25065/P	3x20 lt drawers with bumpers	●
25060	3 Lids for drawers	●
23024/N	1 Plastic basket for buckets without handle holder and hooks for MX/DMX	●
23005 BA	1 Bag-holder equipped with 4 handle holders, lid with document holder and sliding device for MX/DMX	●
23000 KIT	1 Kit rilsan tray holder extension for DMX	●
7079	1 Rilsan support for dispenser Tecno-shower	●
7080	1 Tecno-Shower dispenser	●
24057 KIT	1 Kit VELBOX support - rilsan	●
VELBOX	1 Dispenser for pre-impregnated cloths (VELBOX)	●
25064	2 DMX small keys housings	●
23003/1	1 Upper tray for buckets for MX/DMX	●
23046	1 Rilsan basket for 22 lt bucket for MX/DMX	●
KITDMXPRE/D	1 Assembling kit for DMX COMPACT 5000	●



83x56x155h cm | 1 Pc/2 cartons 36,2 Kg 0,490 m<sup>3</sup>



83x56x155h cm | 1 Pc/2 cartons 37,1 Kg 0,490 m<sup>3</sup>



Code	Description	Color
<b>DMX SPACE 900.2</b>	<b>Multifunctional enclosed plastic trolley</b>	
21001AB/DMX	1 IDEA/AB base equipped with 4 outdoor soft castors Ø 125 mm (item no. 21027)	●
21002IDEA/DMX	1 Base extension equipped with outdoor soft castor Ø 125 mm (item no. 21027) and door stop	●
25050	1 DMX vertical frame without lock - 2 drawers	●
25052	1 DMX vertical frame with lock - 2 drawers	●
23011N	1 Left door for MX/DMX	○
23012N	1 Right door for MX/DMX	○
23020 G	1x4 lt bucket	●
23020 R	1x4 lt bucket	●
2250 BA	1x6 lt bucket	●
2250 G	1x6 lt bucket	●
2250 VS	1x6 lt bucket	●
2253	2 Bottles dividers for 6 lt bucket	●
25066 A	1x30 lt drawer for DMX	●
25066/P	1x30 lt drawer with bumpers	●
25060	1 Lid for drawers	●
23005 BA	1 Bag-holder equipped with 4 handle holders, lid with document holder and sliding device for MX/DMX	●
23016 KIT	1 Kit rilsan tray holder for DMX	●
25064	2 DMX small keys housings	●
23003/1	1 Upper tray for buckets for MX/DMX	●
KITDMXPRE/E	1 Assembling kit for DMX SPACE 900	●

Code	Description	Color
<b>DMX SPACE 900.3</b>	<b>Multifunctional enclosed plastic trolley</b>	
21001AB/DMX	1 IDEA/AB base equipped with 4 outdoor soft castors Ø 125 mm (item no. 21027)	●
21002IDEA/DMX	1 Base extension equipped with outdoor soft castor Ø 125 mm (item no. 21027) and door stop	●
25051	1 DMX vertical frame without lock - 3 drawers	●
25053	1 DMX vertical frame with lock - 3 drawers	●
23011N	1 Left door for MX/DMX	○
23012N	1 Right door for MX/DMX	○
23020 G	1x4 lt bucket	●
23020 R	1x4 lt bucket	●
2250 BA	1x6 lt bucket	●
2250 G	1x6 lt bucket	●
2250 VS	1x6 lt bucket	●
2253	2 Bottles divider for 6 lt bucket	●
25065 A	1x20 lt drawer for DMX	●
25065/P	2x20 lt drawers with bumpers	●
25060	2 Lids for drawers	●
23005 BA	1 Bag-holder equipped with 4 handle holders, lid with document holder and sliding device for MX/DMX	●
23016 KIT	1 Kit rilsan tray holder for DMX	●
25064	2 DMX small keys housings	●
23003/1	1 Upper tray for buckets for MX/DMX	●
KITDMXPRE/E	1 Assembling kit for DMX SPACE 900	●

 **110x56x105h cm** |  **1 Pc/carton** **32,7 Kg** **0,390 m<sup>3</sup>**

 **110x56x105h cm** |  **1 Pc/carton** **33,5 Kg** **0,390 m<sup>3</sup>**



Code	Description	Color
------	-------------	-------

**DMX SPACE 1000.2 Multifunctional enclosed plastic trolley**

21001AB/COMPACT	1 IDEA/AB base equipped with 4 outdoor soft castors Ø 125 mm (item no. 21027) and with door stop	●
21002IDEA/DMX	1 Base extension equipped with outdoor soft castor Ø 125 mm (item no. 21027) and door stop	●
25050	1 DMX vertical frame without lock - 2 drawers	●
25052	1 DMX vertical frame with lock - 2 drawers	●
23011N	2 Left doors for MX/DMX	○
23012N	2 Right doors for MX/DMX	○
23020 G	1x4 lt bucket	●
23020 R	1x4 lt bucket	●
2250 BA	1x6 lt bucket	●
2250 G	1x6 lt bucket	●
2250 VS	1x6 lt bucket	●
2253	2 Bottles dividers for 6 lt bucket	●
25066 A	1x30 lt drawer for DMX	●
25066/P	1x30 lt drawer with bumpers	●
25060	1 Lid for drawers	●
23005 BA	1 Bag-holder equipped with 4 handle holders, lid with document holder and sliding device for MX/DMX	●
23016 KIT	1 Kit rilsan tray holder for DMX	●
25064	2 DMX small keys housings	●
23003/1	1 Upper tray for buckets for MX/DMX	●
KITDMXPRE/F	1 Assembling kit for DMX SPACE 1000	●











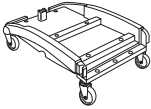

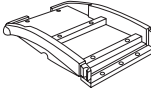

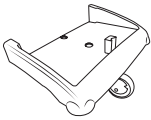
Code	Description	Color
------	-------------	-------

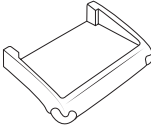

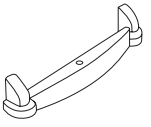

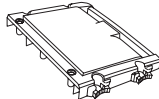
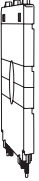
**DMX SPACE 1000.3 Multifunctional enclosed plastic trolley**

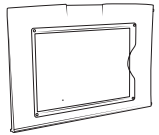
21001AB/COMPACT	1 IDEA/AB base equipped with 4 outdoor soft castors Ø 125 mm (item no. 21027) and with door stop	●
21002IDEA/DMX	1 Base extension equipped with outdoor soft castor Ø 125 mm (item no. 21027) and door stop	●
25051	1 DMX vertical frame without lock - 3 drawers	●
25053	1 DMX vertical frame with lock - 3 drawers	●
23011N	2 Left doors for MX/DMX	○
23012N	2 Right doors for MX/DMX	○
23020 G	1x4 lt bucket	●
23020 R	1x4 lt bucket	●
2250 BA	1x6 lt bucket	●
2250 G	1x6 lt bucket	●
2250 VS	1x6 lt bucket	●
2253	2 Bottles dividers for 6 lt bucket	●
25065 A	1x20 lt drawer for DMX	●
25065/P	2x20 lt drawers with bumpers	●
25060	2 Lids for drawers	●
23005 BA	1 Bag-holder equipped with 4 handle holders, lid with document holder and sliding device for MX/DMX	●
23016 KIT	1 Kit rilsan tray holder for DMX	●
25064	2 DMX small keys housings	●
23003/1	1 Upper tray for buckets for MX/DMX	●
KITDMXPRE/F	1 Assembling kit for DMX SPACE 1000	●

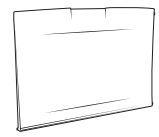

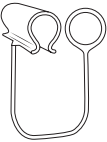
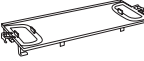
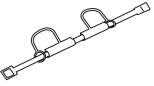
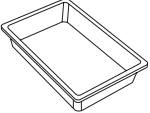
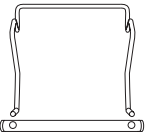
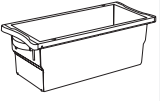
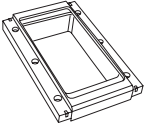
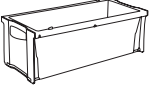
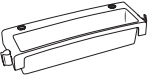
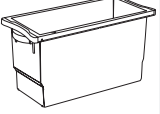
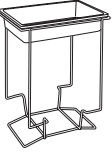
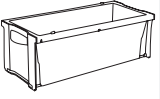
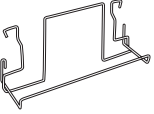
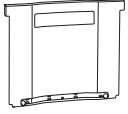

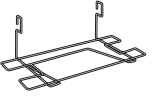





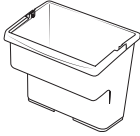

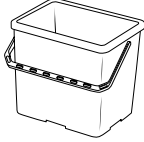

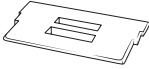

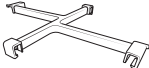
110x56x105h cm | 1 Pc/2 cartons 34,1 Kg 0,550 m<sup>3</sup>

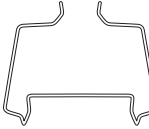
110x56x105 cm | 1 Pc/2 cartons 34,9 Kg 0,550 m<sup>3</sup>

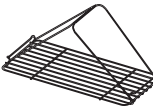
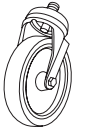
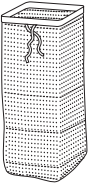

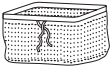

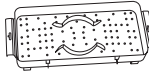

Code	Description	Color	Code	Description	Color
 21001 AB/COMPACT	IDEA/AB base equipped with 4 outdoor soft castors Ø 125 mm (item no. 21027) and with door stop	●	 23014	Key for lock MX and DMX	
 21001 VS	IDEA/AB base without castors	●	 23011N	Left door for MX/DMX	○
 21002 IDEA/DMX	Base extension equipped with outdoor soft castor Ø 125 mm (item no. 21027) and door stop	●	 23012N	Right door for MX/DMX	○
 21002 B	Base extension without castor	●	 23010 N	Complete set of doors MX/DMX	○
 21003 B	Base end	●	 23080	Latch for MX/DMX doors	●
 25050	DMX vertical frame without lock - 2 drawers		 23005 BA	Bag-holder equipped with 4 handle holders, lid with document holder and sliding device for MX/DMX	●
 25051	DMX vertical frame without lock - 3 drawers		 23005/100B	Bag-holder without lid equipped with 4 handle holders for MX/DMX	●
 25052	DMX vertical frame with lock - 2 drawers		 23006 B	Lid with transparent document holder for plastic bag-holder	●
 25053	DMX vertical frame with lock - 3 drawers		 23006/N	Lid without transparent document holder for plastic bag-holder	●

Code	Description	Color	Code	Description	Color
	1701 Plastic clip with ring	●		VELBOX Dispenser for pre-impregnated cloths (VELBOX)	
	2709 Plastic device with clips for plastic bag holder	●		23015 GR Tray MX	○
	23100 Roll holder for bag holder			25065/P 20 lt drawer with bumpers	
	23003/1 Upper tray for buckets for MX/DMX	●		25065 A 25065 G 25065 R 25065 V 20 lt drawer for DMX	● ● ● ●
	23024 Plastic basket for buckets with handle holder and hook for MX/DMX	●		25066/P 30 lt drawer with bumpers	
	23000KIT Rilsan tray holder kit with: - rilsan extension - plastic tray for MX (item no. 23015 GR)			25066 A 25066 G 25066 R 25066 V 30 lt drawer for DMX	● ● ● ●
	23023 KIT Rilsan bucket-holder kit with: - 2x4lt rilsan bucket-holder - hinges right (item no. 23070), left (item no. 23071) - 4 screws (item no. 4221)			25069 Front cover for DMX 20 lt drawer 25070 Front cover for DMX 30 lt drawer	● ●
	23016 KIT Rilsan tray-holder kit with: - rilsan tray-holder (item no. 23016) - plastic tray for MX (item no. 23015 GR)			25067 Edge protection for drawer	○
	24057 KIT Rilsan VELBOX kit with: - rilsan VELBOX support - hinges right (item no. 23070), left (item no. 23071) - 4 screws (item no. 4221)			25060 Lid for drawers	●

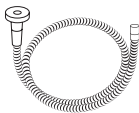

	Code	Description	Color		Code	Description	Color
	23020 B 23020 G 23020 R 23020 VS	4 lt bucket	● ● ● ●		21008	Natural rubber castor Ø 100 mm without brake with thread 10x15	
	2250 BA 2250 G 2250 VS 2250 R	6 lt bucket	● ● ● ●		21009	Natural rubber castor Ø 100 mm with brake with thread 10x15	
	23021	Lid for 4 lt bucket	●		21027	Outdoor soft castor Ø 125 mm	
	2253	Bottles divider for 6 lt bucket	●		21028	Outdoor soft castor Ø 125 mm spec. without brake (to be used with item no. 21029 only)	
	7079	Rilsan support for dispenser Tecno-Shower			21029	Outdoor soft castor Ø 125 mm spec. with brake (to be used with item no. 21028 only)	
	7032	Folding stainless steel grid (for 22 lt rect. bucket)			24060	Castor Ø 100 mm with thread 10x15	
	23095	Net bag 70 lt with closing string			24061	Castor Ø 100 mm XL without brake with thread 10x15	
	23097	Net bag for 22 lt bucket with closing string			24062	Castor Ø 100 mm XL with brake with thread 10x15	
	7080	Tecno-Shower dispenser	●		21012	Castor Ø 125 mm XL without brake with thread 10x15	

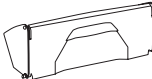
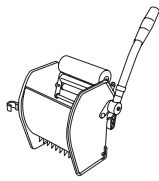
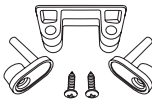
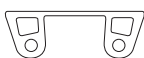
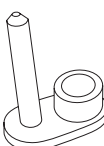

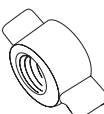
Code	Description	Color	Code	Description	Color
	1071 FAST water hose			21035 B Threaded pin	●
	4260/2 Sign panel (SLIPPERY FLOOR / WET FLOOR)			21030 B Plug for base	●
	25064 DMX small key housing	●		3501 VDM Roller wringer ELPAROLL	
	KIT23030 Rubber handle holder kit				
	23030 Rubber handle holder				
	23031 Support for rubber handle holder	●			
	2231/G Hook without junction	●			
	2230/DMX Handle holder without coupling for bottles basket	○			
	21036 Threaded ring nut	●			



# Hotel Line

---

Classic	270
Innovative	280
Elba	294

# Hotel Line

---



**Castors fixing.** The wheels are applied with a four point fixing support firmly held between the base and a stainless steel plate with thickness 1,5 mm.



**The structure.** Square tube, thickness 1,5 mm and anti-scratch epoxy powder painting.



**Practicality.** Practical plastic trays to store courtesy products.



**Modular.** Equipped with two practical adjustable shelves to store the clean linen.



**Bumpers.** Equipped with rubber bumpers on all the base perimeter and on the bag holder to prevent damages to furniture and walls.



**Modularity and flexibility.** Reclining bag holders to reduce the overall dimensions of the trolley.



Code	Description	Color
<b>90002</b>	<b>Hotel trolley PORTOFINO 1 (walnut) stainless steel with anti scratch painting</b>	
90052	1 PORTOFINO base equipped with 2 natural rubber castors Ø 150 mm with brake (item no. 90051) and 2 without brake (item no. 90050)	
90056	2 Vertical frames for HOTEL - walnut	
GR7043/V	1 Removable bag holder with rubber ring for HOTEL	
90090	1 Set of reclining bag holder and bag support with bumpers equipped with fixing plates and sanforized canvas bag 120 lt	
90057	1 Back panel PORTOFINO	
90054	1 Fixing rod for PORTOFINO	
GR90058	1 Fixing rod with insert for PORTOFINO	
2025/M	1 Tray small	
90053	3 Shelves for PORTOFINO	
KITCLASSIC/A	1 Assembling kit PORTOFINO/AMALFI/VENEZIA 1	

From 8 to 12 rooms



Code	Description	Color
<b>90004</b>	<b>Hotel trolley PORTOFINO 2 (walnut) stainless steel with anti scratch painting</b>	
90052	1 PORTOFINO base equipped with 2 natural rubber castors Ø 150 mm with brake (item no. 90051) and 2 without brake (item no. 90050)	
90056	2 Vertical frames for HOTEL - walnut	
90090	2 Sets of reclining bag holder and bag support with bumpers equipped with fixing plates and sanforized canvas bag 120 lt	
90057	1 Back panel PORTOFINO	
90054	1 Fixing rod for PORTOFINO	
GR90058	1 Fixing rod with insert for PORTOFINO	
2025/M	1 Tray small	
90053	3 Shelves for PORTOFINO	
KITCLASSIC/B	1 Assembling kit PORTOFINO/AMALFI/VENEZIA 2	

From 8 to 12 rooms

 90x57x130h cm

 1 Pc/2 cartons 50 Kg 0,260 m<sup>3</sup>

 154x57x131h cm (65x57x150h cm)

 1 Pc/2 cartons 53 Kg 0,260 m<sup>3</sup>





Code	Description	Color
<b>90007</b>	<b>Hotel trolley AMALFI 1 (walnut) stainless steel with anti scratch painting</b>	
90071	1 AMALFI base equipped with 2 natural rubber castors Ø 150 mm with brake (item no. 90051) and 2 without brake (item no. 90050)	
90056	2 Vertical frames for HOTEL - walnut	
GR7043/V	1 Removable bag holder with rubber ring for HOTEL	
90090	1 Set of reclining bag holder and bagsupport with bumpers equipped with fixing plates and sanforized canvas bag 120 lt	
90095	1 Fixing rod for AMALFI	
GR90094	Fixing rod with inserts for AMALFI	
2024/M	1 Tray mini	●
2025/M	1 Tray small	●
90091	3 Shelves for AMALFI	
90093	1 Set of back panels for AMALFI	
KITCLASSIC/A	1 Assembling kit PORTOFINO/AMALFI/VENEZIA 1	

From 12 to 15 rooms

Code	Description	Color
<b>90009</b>	<b>Hotel trolley AMALFI 2 (walnut) stainless steel with anti scratch painting</b>	
90071	1 AMALFI base equipped with 2 natural rubber castors Ø 150 mm with brake (item no. 90051) and 2 without brake (item no. 90050)	
90056	2 Vertical frames for HOTEL - walnut	
90090	2 Sets of reclining bag holder and bag support with bumpers equipped with fixing plates and sanforized canvas bag 120 lt	
2024/M	1 Tray mini	●
2025/M	1 Tray small	●
90091	3 Shelves for AMALFI	
90093	1 Set of back panels for AMALFI	
KITCLASSIC/B	1 Assembling kit PORTOFINO/AMALFI/VENEZIA 2	

From 12 to 15 rooms

 115x57x130h cm |  1 Pc/2 cartons 58 Kg 0,260 m<sup>3</sup>

 174x57x131h cm |  1 Pc/2 cartons 61 Kg 0,260 m<sup>3</sup>





Code	Description	Color
<b>90011</b>	<b>Hotel trolley VENEZIA 1 (walnut) stainless steel with anti scratch painting</b>	
90100	1 VENEZIA base equipped with 2 natural rubber castors Ø 150 mm with brake (item no. 90051) and 2 without brake (item no. 90050)	
90056	2 Vertical frames for HOTEL - walnut	
GR7043/V	1 Removable bag holder with rubber ring for HOTEL	
90090	1 Set of reclining bag holder and bag support with bumpers equipped with fixing plates and sanforized canvas bag 120 lt	
90108	1 Fixing rod for VENEZIA	●
GR90107	1 Fixing rod with inserts for VENEZIA	
2025/M	2 Trays small	
90102	3 Shelves for VENEZIA	
90106	6 Profiles for shelves VENEZIA	
90109	1 Set of back panels for VENEZIA	
KITCLASSIC/A	1 Assembling kit PORTOFINO AMALFI/VENEZIA 1	

From 15 to 18 rooms

 145x57x130h cm



1 Pc/2 cartons 65 Kg 0,260 m<sup>3</sup>



Code	Description	Color
<b>90013</b>	<b>Hotel trolley VENEZIA 2 (walnut) stainless steel with anti scratch painting</b>	
90100	1 VENEZIA base equipped with 2 natural rubber castors Ø 150 mm with brake (item no. 90051) and 2 without brake (item no. 90050)	
90056	2 Vertical frames for HOTEL - walnut	
90090	2 Sets of reclining bag holder and bag support with bumpers equipped with fixing plates and sanforized canvas bag 120 lt	
90108	1 Fixing rod for VENEZIA	●
GR90107	1 Fixing rod with inserts for VENEZIA	
2025/M	2 Trays small	
90106	6 Profiles for shelves VENEZIA	
90109	1 Set of back panels for VENEZIA	
KITCLASSIC/B	1 Assembling kit PORTOFINO AMALFI/VENEZIA 2	

From 15 to 18 rooms

 194x57x131h cm (105x57x150hcm)



1 Pc/2 cartons 68 Kg 0,260 m<sup>3</sup>







Code	Description	Color
<b>90020</b>	<b>Hotel trolley AMALFI ELEGANCE 1 (walnut) stainless steel with anti scratch painting</b>	
90071	1 AMALFI base equipped with 2 natural rubber castors Ø 150 mm with brake (item no. 90051) and 2 without brake (item no. 90050)	
90056	2 Vertical frames for HOTEL - walnut	
GR7043/V	1 Removable bag holder with rubber ring for HOTEL	
90090	1 Set of reclining bag holder and bag support with bumpers equipped with fixing plates and sanforized canvas bag 120 lt	
GR90094	1 Fixing rod with inserts for AMALFI	
90095	1 Fixing rod for AMALFI	●
2024/M	1 Tray mini	●
2025/M	1 Tray small	
90091	4 Shelves for AMALFI	
90093	1 Set of back panels for AMALFI	
90150/N	1 Set of panels for AMALFI ELEGANCE doors	
KITELEGANCE/A	1 Assembling kit for ELEGANCE/CATERING 1	
KITELEGANCE/C	1 Assembling kit for doors with lock for ELEGANCE	

From 8 to 15 rooms

Code	Description	Color
<b>90022</b>	<b>Hotel trolley AMALFI ELEGANCE 2 (walnut) stainless steel with anti scratch painting</b>	
90071	1 AMALFI base equipped with 2 natural rubber castors Ø 150 mm with brake (item no. 90051) and 2 without brake (item no. 90050)	
90056	2 Vertical frames for HOTEL - walnut	
90090	2 Sets of reclining bag holder and bag support with bumpers equipped with fixing plates and sanforized canvas bag 120 lt	
GR90094	1 Fixing rod with inserts for AMALFI	
90095	1 Fixing rod for AMALFI	●
2024/M	1 Tray mini	●
2025/M	1 Tray small	
90091	4 Shelves for AMALFI	
90093	1 Set of back panels for AMALFI	
90150/N	1 Set of panels for AMALFI ELEGANCE doors	
KITELEGANCE/B	1 Assembling kit for ELEGANCE/CATERING 2	
KITELEGANCE/C	1 Assembling kit for doors with lockfor ELEGANCE	

From 8 to 15 rooms

 115x57x130h cm |  1 Pc/2 cartons 63,5 Kg 0,260 m<sup>3</sup>

 150x57x130h cm |  1 Pc/2 cartons 67 Kg 0,260 m<sup>3</sup>



Code	Description	Color
<b>90028</b>	<b>Hotel trolley AMALFI CATERING (walnut) stainless steel with anti scratch painting</b>	
90071	1 AMALFI base equipped with 2 natural rubber castors Ø 150 mm with brake (item no. 90051) and 2 without brake (item no. 90050)	
90056	2 Vertical frames for HOTEL - walnut	
90125	1 Complete set of 2 pushing handles with bumpers and fixing plates for AMALFI/VENEZIA CATERING	
GR90094	1 Fixing rod with inserts for AMALFI	
90095	1 Fixing rod for AMALFI	●
2024/M	1 Tray mini	●
2025/M	1 Tray small	
90091	4 Shelves for AMALFI	
90093	1 Set of back panels for AMALFI	
90150/N	1 Set of panels for AMALFI ELEGANCE doors	
KITCATERING	1 Assembling kit CATERING/BAG	
KITELEGANCE/C	1 Assembling kit for doors with lock for ELEGANCE	



Code	Description	Color
<b>90024</b>	<b>Hotel trolley VENEZIA ELEGANCE 1 (walnut) stainless steel with anti scratch painting</b>	
90100	1 VENEZIA base equipped with 2 natural rubber castors Ø 150 mm with brake (item no. 90051) and 2 without brake (item no. 90050)	
90056	2 Vertical frames for HOTEL - walnut	
GR7043/V	1 Removable bag holder with rubber ring for HOTEL	
90090	1 Set of reclining bag holder and bag support with bumpers equipped with fixing plates and sanforized canvas bag 120 lt	
2025/M	2 Trays small	●
GR90107	1 Fixing rod with inserts for VENEZIA	
90108	1 Fixing rod for VENEZIA	
90102	4 Shelves for VENEZIA	
90106	8 Profiles for shelves VENEZIA	
90109	1 Set of back panels for VENEZIA	
90152/N	1 Set of panels for VENEZIA ELEGANCE doors	
KITELEGANCE/A	1 Assembling kit for ELEGANCE/CATERING 1	
KITELEGANCE/C	1 Assembling kit for doors with lock for ELEGANCE	

From 15 to 18 rooms



121x57x131h cm  
(85x57x131h cm)



1 Pc/2 cartons 61 Kg 0,260 m<sup>3</sup>



145x57x130h cm



1 Pc/2 cartons 69 Kg 0,260 m<sup>3</sup>



Code	Description	Color
<b>90026</b>	<b>Hotel trolley VENEZIA ELEGANCE 2 (walnut) stainless steel with anti scratch painting</b>	
90100	1 VENEZIA base equipped with 2 natural rubber castors Ø 150 mm with brake (item no. 90051) and 2 without brake (item no. 90050)	
90056	2 Vertical frames for HOTEL - walnut	
90090	2 Sets of reclining bag holder and bag support with bumpers equipped with fixing plates and sanforized canvas bag 120 lt	
2025/M	2 Trays small	●
GR90107	1 Fixing rod with inserts for VENEZIA	
90108	1 Fixing rod for VENEZIA	
90102	4 Shelves for VENEZIA	
90106	8 Profiles for shelves VENEZIA	
90109	1 Set of back panels for VENEZIA	
90152/N	1 Set of panels for VENEZIA ELEGANCE doors	
KITELEGANCE/B	1 Assembling kit for ELEGANCE/CATERING 2	
KITELEGANCE/C	1 Assembling kit for doors with lock for ELEGANCE	

Code	Description	Color
<b>90030</b>	<b>Hotel trolley VENEZIA CATERING (walnut) stainless steel with anti scratch painting</b>	
90100	1 VENEZIA base equipped with 2 natural rubber castors Ø 150 mm with brake (item no. 90051) and 2 without brake (item no. 90050)	
90056	2 Vertical frames for HOTEL - walnut	
90125	1 Complete set of 2 pushing handles with bumpers and fixing plates for AMALFI/VENEZIA CATERING	
2025/M	2 Trays small	●
90108	1 Fixing rod for VENEZIA	
GR90107	1 Fixing rod with inserts for VENEZIA	
90102	4 Shelves for VENEZIA	
90106	8 Profiles for shelves VENEZIA	
90109	1 Set of back panels for VENEZIA	
90152/N	1 Set of panels for VENEZIA ELEGANCE doors	
KITCATERING	1 Assembling kit CATERING/BAG	
KITELEGANCE/C	1 Assembling kit for doors with lock for ELEGANCE	

From 15 to 18 rooms

 190x57x130h cm |  1 Pc/2 cartons 73 Kg 0,260 m<sup>3</sup>

 141x57x131h cm |  1 Pc/2 cartons 71 Kg 0,260 m<sup>3</sup>  
(105x57x131h cm)



Code	Description	Color
<b>90035</b>	<b>Hotel trolley AMALFI BAG stainless steel with anti scratch painting</b>	
90071/BAG	1 AMALFI BAG base equipped with 2 natural rubber castors Ø 150 mm with brake (item no. 90051) and 2 without brake (item no. 90050) with bumpers	
90240/BAG	2 Frames BAG with crossbars	
90244	1 Medium bar for AMALFI BAG	
KITCATERING	1 Assembling kit CATERING/BAG	

**Luggage capacity: 6-8**  
**Unladen weight: 26 Kg**



Code	Description	Color
<b>90036</b>	<b>Hotel trolley VENEZIA BAG stainless steel with anti scratch painting</b>	
90100/BAG	1 VENEZIA BAG base with 2 natural rubber castors Ø 150 mm with brake (item no. 90051) and 2 without brake (item no. 90050) with bumpers	
90240/BAG	2 Frames BAG with crossbars	
90245	1 Long bar for VENEZIA bag	
KITCATERING	1 Assembling kit CATERING/BAG	









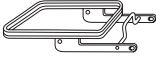

**Luggage capacity: 8-10**  
**Unladen weight: 28 Kg**

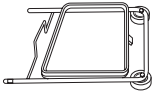
 **85x57x187h cm** |  **1 Pc/2 cartons 30 Kg 0,220 m³**

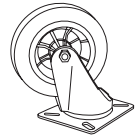
 **105x57x187h cm** |  **1 Pc/2 cartons 32 Kg 0,220 m³**

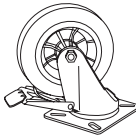

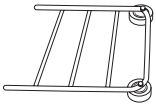
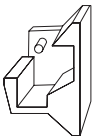
Code	Description	Color
<b>90061 SET</b>	<b>Complete luggage support kit</b>	
GR90061	1 Bag support with bumpers for HOTEL	
KIT90065	1 Complete set of aluminum plates for HOTEL CLASSIC	

Code	Description	Color	Code	Description	Color
 GR7043/V	Removable bag holder with rubber ring for HOTEL		 2024/M	Tray mini	●
 GR90060	Bag holder with rubber and bumpers for HOTEL		 2025/M	Tray small	●
 7031	Rectangular lid	●	 90050	Natural rubber castor $\varnothing$ 150 mm without brake - plate coupling for HOTEL base	
 7031 M	Lid for EF/HO	●	 90051	Natural rubber castor $\varnothing$ 150 mm with brake - plate coupling for HOTEL base	
 1622	Rubber ring large				
 2710	Complete device for bag-holder (with 2 clips item no. 1701)	● ●			
 GR90061	Bag support with bumpers for HOTEL				
 KIT90065	Complete set of aluminum plates for HOTEL CLASSIC				
 1680	Sanforized canvas bag 120 lt				







Code	Description	Color
<b>80001</b>	<b>Hotel trolley CAPRI 1</b>	
80025IDEA/BASE	1 Maxi base IDEA equipped with 2 castors with brake (item no. 80061) and 2 castors without brake (item no. 80060) Ø 125 mm	●
21003 B	2 Base ends	●
80051	2 High vertical frames for CAPRI/ISCHIA/LINOSA	●
80055	1 Reclining bag holder for CAPRI/ISCHIA/LINOSA	
80030	1 Nylon bag 150 lt with blue border for CAPRI/ISCHIA/LINOSA	
80045	2 Shelves for CAPRI/ISCHIA	●
GR80046	1 Drawer with lock for HOTEL	
GR80052/SET	1 Set of 6 short crossbars CAPRI	
KITINNOVATIVE/A	1 Assembling kit for 80001	

From 8 to 10 rooms



Code	Description	Color
<b>80001/C</b>	<b>Hotel trolley CAPRI 1C enclosed</b>	
80025IDEA/BASE	1 Maxi base IDEA equipped with 2 castors with brake (item no. 80061) and 2 castors without brake (item no. 80060) Ø 125 mm	●
21003 B	2 Base ends	●
80051	2 High vertical frames for CAPRI/ISCHIA/LINOSA	●
80055	1 Reclining bag holder for CAPRI/ISCHIA/LINOSA	
80030	1 Nylon bag 150 lt with blue border for CAPRI/ISCHIA/LINOSA	
80045	3 Shelves for CAPRI/ISCHIA	●
GR80046	1 Drawer with lock for HOTEL	
80032	1 Nylon enclosing panel on 3 sides for CAPRI	
GR80052/SET	1 Set of 6 short crossbars CAPRI	
KITINNOVATIVE/A	1 Assembling kit for 80001	

From 8 to 10 rooms

 110x55x152h cm



1 Pc/2 cartons 20 Kg

0,300 m<sup>3</sup>

 110x55x152h cm



1 Pc/2 cartons 23,5 Kg

0,300 m<sup>3</sup>







Code	Description	Color
<b>80002</b>	<b>Hotel trolley CAPRI 2</b>	
80025IDEA/BASE	1 Maxi base IDEA equipped with 2 castors with brake (item no. 80061) and 2 castors without brake (item no. 80060) Ø 125 mm	●
21003 B	2 Base ends	●
80051	2 High vertical frames for CAPRI/ISCHIA/LINOSA	●
80055	2 Reclining bag holders for CAPRI/ISCHIA/LINOSA	●
80030	2 Nylon bags 150 lt with blue border for CAPRI/ISCHIA/LINOSA	●
80045	3 Shelves for CAPRI/ISCHIA	●
GR80046	1 Drawer with lock for HOTEL	●
GR80052/SET	1 Set of 6 short crossbars CAPRI	●
KITINNOVATIVE/B	1 Assembling kit for 80002	●

From 8 to 12 rooms

Code	Description	Color
<b>80002/C</b>	<b>Hotel trolley CAPRI 2C enclosed</b>	
80025IDEA/BASE	1 Maxi base IDEA equipped with 2 castors with brake (item no. 80061) and 2 castors without brake (item no. 80060) Ø 125 mm	●
21003 B	2 Base ends	●
80051	2 High vertical frames for CAPRI/ISCHIA/LINOSA	●
80055	2 Reclining bag holders for CAPRI/ISCHIA/LINOSA	●
80030	2 Nylon bags 150 lt with blue border for CAPRI/ISCHIA/LINOSA	●
80045	3 Shelves for CAPRI/ISCHIA	●
GR80046	1 Drawer with lock for HOTEL	●
80032	1 Nylon enclosing panel on 3 sides for CAPRI	●
GR80052/SET	1 Set of 6 short crossbars CAPRI	●
KITINNOVATIVE/B	1 Assembling kit for 80002	●

From 8 to 12 rooms

 150/110x55x152h cm |  1 Pc/2 cartons 22 Kg 0,300 m<sup>3</sup>

 150/110x55x152h cm |  1 Pc/2 cartons 25,5 Kg 0,300 m<sup>3</sup>



Code	Description	Color
<b>80003</b>	<b>Hotel trolley CAPRI 3</b>	
80025IDEA/BASE	1 Maxi base IDEA equipped with 2 castors with brake (item no. 80061) and 2 castors without brake (item no. 80060) Ø 125 mm	●
80043IDEA/BASE	1 Maxi base extension with 1 castor Ø 125 mm without brake (item no. 80060)	●
21003 B	1 Base end	●
80051	2 High vertical frames for CAPRI/ISCHIA/LINOSA	●
80055	2 Reclining bag holders for CAPRI/ISCHIA/LINOSA	●
80030	2 Nylon bags 150 lt with blue border for CAPRI/ISCHIA/LINOSA	●
80045	3 Shelves for CAPRI/ISCHIA	●
GR80046	1 Drawer with lock for HOTEL	●
GR80052/SET	1 Set of 6 short crossbars CAPRI	
KITINNOVATIVE/C	1 Assembling kit for 80003	

From 8 to 12 rooms



Code	Description	Color
<b>80003/C</b>	<b>Hotel trolley CAPRI 3C enclosed</b>	
80025IDEA/BASE	1 Maxi base IDEA equipped with 2 castors with brake (item no. 80061) and 2 castors without brake (item no. 80060) Ø 125 mm	●
80043IDEA/BASE	1 Maxi base extension with 1 castor Ø 125 mm without brake (item no. 80060)	●
21003 B	1 Base end	●
80051	2 High vertical frames for CAPRI/ISCHIA/LINOSA	●
80055	2 Reclining bag holders for CAPRI/ISCHIA/LINOSA	●
80030	2 Nylon bags 150 lt with blue border for CAPRI/ISCHIA/LINOSA	●
80045	3 Shelves for CAPRI/ISCHIA	●
GR80046	1 Drawer with lock for HOTEL	●
80032	1 Nylon enclosing panel on 3 sides for CAPRI	●
GR80052/SET	1 Set of 6 short crossbars CAPRI	
KITINNOVATIVE/C	1 Assembling kit for 80003	

From 8 to 12 rooms

140x55x152h cm



1 Pc/2 cartons

24 Kg

0,300 m<sup>3</sup>

140x55x152h cm



1 Pc/2 cartons

28 Kg

0,300 m<sup>3</sup>





Code	Description	Color
<b>80004</b>	<b>Hotel trolley CAPRI 4</b>	
80025IDEA/BASE	1 Maxi base IDEA equipped with 2 castors with brake (item no. 80061) and 2 castors without brake (item no. 80060) Ø 125 mm	●
21003 B	2 Base ends	●
80051	2 High vertical frames for CAPRI/ISCHIA/LINOSA	●
80055	1 Reclining bag holder for CAPRI/ISCHIA/LINOSA	●
80030	1 Nylon bag 150 lt with blue border for CAPRI/ISCHIA/LINOSA	●
80045	3 Shelves for CAPRI/ISCHIA	●
GR80046	1 Drawer with lock for HOTEL	●
80032	1 Nylon enclosing panel on 3 sides for CAPRI	●
2723	1 Basket for bottles	●
21005 B	1x15 lt bucket for IDEA	●
21005 R	1x15 lt bucket for IDEA	●
GR21020	1 Rilsan wringer support for IDEABASE	●
3501 VDM	1 Roller wringer ELPAROLL	●
GR80052/SET	1 Set of 6 short crossbars CAPRI	●
KITINNOVATIVE/D	1 Assembling kit with 2 handle holders (item no. 2255) for 80004	●

From 8 to 12 rooms

Code	Description	Color
<b>80005</b>	<b>Hotel trolley CAPRI 5</b>	
80025IDEA/BASE	1 Maxi base IDEA equipped with 2 castors with brake (item no. 80061) and 2 castors without brake (item no. 80060) Ø 125 mm	●
21003 B	2 Base ends	●
80051	2 High vertical frames for CAPRI/ISCHIA/LINOSA	●
80055	1 Reclining bag holder for CAPRI/ISCHIA/LINOSA	●
80030	1 Nylon bag 150 lt with blue border for CAPRI/ISCHIA/LINOSA	●
80045	3 Shelves for CAPRI/ISCHIA	●
GR80046	1 Drawer with lock for HOTEL	●
80032	1 Nylon enclosing panel on 3 sides for CAPRI	●
2723	1 Basket for bottles	●
2270 R	1x13 lt rect. bucket	●
7030 B	1x22 lt rect. bucket	●
80056	1 Nylon bag for 13 lt bucket for CAPRI/ISCHIA	●
7032	1 Folding stainless steel grid (for 22 lt rect. bucket)	●
GR80052/SET	1 Set of 6 short crossbars CAPRI	●
KITINNOVATIVE/E	1 Assembling kit with 2 handle holders (item no. 2255) for 80005-80006	●

From 8 to 12 rooms

	150/110x55x152h cm		1 Pc/2 cartons	33 Kg	0,300 m <sup>3</sup>
--	--------------------	--	----------------	-------	----------------------

	150/110x55x152h cm		1 Pc/2 cartons	29 Kg	0,300 m <sup>3</sup>
--	--------------------	--	----------------	-------	----------------------



Code	Description	Color
<b>80006</b>	<b>Hotel trolley CAPRI 6</b>	
80025IDEA/BASE	1 Maxi base IDEA equipped with 2 castors with brake (item no. 80061) and 2 castors without brake (item no. 80060) Ø 125 mm	●
21003 B	2 Base ends	●
80051	2 High vertical frames for CAPRI/ISCHIA/LINOSA	●
80055	1 Reclining bag holder for CAPRI/ISCHIA/LINOSA	●
80030	1 Nylon bag 150 lt with blue border for CAPRI/ISCHIA/LINOSA	●
80045	3 Shelves for CAPRI/ISCHIA	●
GR80046	1 Drawer with lock for HOTEL	●
80032	1 Nylon enclosing panel on 3 sides for CAPRI	●
2723	1 Basket for bottles	●
2270 R	1x13 lt rect. bucket	●
7030 B	1x22 lt rect. bucket	●
80056	1 Nylon bag for 13 lt bucket for CAPRI/ISCHIA	●
7038	1 Lid for 22 lt rect. bucket	●
GR80052/SET	1 Set of 6 short crossbars CAPRI	●
KITINNOVATIVE/E	1 Assembling kit with 2 handle holders (item no. 2255) for 80005-80006	●

From 8 to 12 rooms

150/110x55x152cm | 1 Pc/2 cartons 28 Kg 0,300 m<sup>3</sup>



Code	Description	Color
<b>80007</b>	<b>Hotel trolley CAPRI 7</b>	
80025IDEA/BASE	1 Maxi base IDEA equipped with 2 castors with brake (item no. 80061) and 2 castors without brake (item no. 80060) Ø 125 mm	●
21003 B	2 Base ends	●
GR21016/CAPRI	1 Straight vertical frame in rilsan with bag holder, rubber ring and basket for 22 lt bucket for IDEABASE	●
80051	2 High vertical frames for CAPRI/ISCHIA/LINOSA	●
80055	1 Reclining bag holder for CAPRI/ISCHIA/LINOSA	●
7031 BSV	1 Rectangular lid	●
80030	1 Nylon bag 150 lt with blue border for CAPRI/ISCHIA/LINOSA	●
80045	3 Shelves for CAPRI/ISCHIA	●
GR80046	1 Drawer with lock for HOTEL	●
80032	1 Nylon enclosing panel on 3 sides for CAPRI	●
24053	1 Basket for IDEA	●
7030 B	1x22 lt rect. bucket	●
7038	1 Lid for 22 lt rect. bucket	●
GR80052/SET	1 Set of 6 short crossbars CAPRI	●
KITINNOVATIVE/F	1 Assembling kit with 2 handle holders (item no. 2255) for 80007	●

From 8 to 12 rooms

160/110x55x152cm | 1 Pc/2 cartons 32 Kg 0,300 m<sup>3</sup>



Code	Description	Color
------	-------------	-------

<b>80011</b>	<b>Hotel trolley ISCHIA 11</b>	
80025IDEA/BASE	1 Maxi base IDEA equipped with 2 castors with brake (item no. 80061) and 2 castors without brake (item no. 80060) Ø 125 mm	●
21003 B	2 Base ends	●
80051	2 High vertical frames for CAPRI/ISCHIA/LINOSA	
80055	1 Reclining bag holder for CAPRI/ISCHIA/LINOSA	
80030	1 Nylon bag 150 lt with blue border for CAPRI/ISCHIA/LINOSA	
80045	6 Shelves for CAPRI/ISCHIA	●
GR80046	2 Drawers with lock for HOTEL	
GR80053/SET	1 Set of 6 long crossbars ISCHIA	
KITINNOVATIVE/G	1 Assembling kit for 80011	

From 12 to 15 rooms

Code	Description	Color
------	-------------	-------

<b>80011/C</b>	<b>Hotel trolley ISCHIA 11C enclosed</b>	
80025IDEA/BASE	1 Maxi base IDEA equipped with 2 castors with brake (item no. 80061) and 2 castors without brake (item no. 80060) Ø 125 mm	●
21003 B	2 Base ends	●
80051	2 High vertical frames for CAPRI/ISCHIA/LINOSA	
80055	1 Reclining bag holder for CAPRI/ISCHIA/LINOSA	
80030	1 Nylon bag 150 lt with blue border for CAPRI/ISCHIA/LINOSA	
80045	6 Shelves for CAPRI/ISCHIA	●
GR80046	2 Drawers with lock for HOTEL	
80034	1 Nylon enclosing panel on 3 sides for ISCHIA	
GR80053/SET	1 Set of 6 long crossbars ISCHIA	
KITINNOVATIVE/G	1 Assembling kit for 80011	

From 12 to 15 rooms

 150/110x55x152hcm |  1 Pc/2 cartons 25 Kg 0,300 m³

 150/110x55x152hcm |  1 Pc/2 cartons 29,5 Kg 0,300 m³





Code	Description	Color
<b>80012</b>	<b>Hotel trolley ISCHIA 12</b>	
80025IDEA/BASE	1 Maxi base IDEA equipped with 2 castors with brake (item no. 80061) and 2 castors without brake (item no. 80060) Ø 125 mm	●
21003 B	2 Base ends	●
80051	2 High vertical frames for CAPRI/ISCHIA/LINOSA	●
80055	2 Reclining bag holders for CAPRI/ISCHIA/LINOSA	
80030	2 Nylon bags 150 lt with blue border for CAPRI/ISCHIA/LINOSA	
80045	6 Shelves for CAPRI/ISCHIA	●
GR80046	2 Drawers with lock for HOTEL	
GR80053/SET	1 Set of 6 long crossbars ISCHIA	
KITINNOVATIVE/H	Assembling kit for 80012	

From 15 to 18 rooms

190/110x55x152h cm | 1 Pc/2 cartons 26 Kg 0,300 m<sup>3</sup>



Code	Description	Color
<b>80012/C</b>	<b>Hotel trolley ISCHIA 12C enclosed</b>	
80025IDEA/BASE	1 Maxi base IDEA equipped with 2 castors with brake (item no. 80061) and 2 castors without brake (item no. 80060) Ø 125 mm	●
21003 B	2 Base ends	●
80051	2 High vertical frames for CAPRI/ISCHIA/LINOSA	●
80055	2 Reclining bag holders for CAPRI/ISCHIA/LINOSA	
80030	2 Nylon bags 150 lt with blue border for CAPRI/ISCHIA/LINOSA	
80045	6 Shelves for CAPRI/ISCHIA	●
GR80046	2 Drawers with lock for HOTEL	
80034	1 Nylon enclosing panel on 3 sides for ISCHIA	
GR80053/SET	1 Set of 6 long crossbars ISCHIA	
KITINNOVATIVE/H	Assembling kit for 80012	

From 15 to 18 rooms

190/110x55x152h cm | 1 Pc/2 cartons 30 Kg 0,300 m<sup>3</sup>



Code	Description	Color
<b>80013</b>	<b>Hotel trolley ISCHIA 13</b>	
80025IDEA/BASE	1 Maxi base IDEA equipped with 2 castors with brake (item no. 80061) and 2 castors without brake (item no. 80060) Ø 125 mm	●
80043IDEA/BASE	1 Maxi base extension with 1 castor Ø 125 mm without brake (item no. 80060)	●
21003 B	1 Base end	●
80051	2 High vertical frames for CAPRI/ISCHIA/LINOSA	
80055	2 Reclining bag holders for CAPRI/ISCHIA/LINOSA	
80030	2 Nylon bags 150 lt with blue border for CAPRI/ISCHIA/LINOSA	
80045	6 Shelves for CAPRI/ISCHIA	●
GR80046	2 Drawers with lock for HOTEL	
GR80053/SET	1 Set of 6 long crossbars ISCHIA	
KITINNOVATIVE/I	1 Assembling kit for 80013	

From 15 to 18 rooms

Code	Description	Color
<b>80013/C</b>	<b>Hotel trolley ISCHIA 13C enclosed</b>	
80025IDEA/BASE	1 Maxi base IDEA equipped with 2 castors with brake (item no. 80061) and 2 castors without brake (item no. 80060) Ø 125 mm	●
80043IDEA/BASE	1 Maxi base extension with 1 castor Ø 125 mm without brake (item no. 80060)	●
21003 B	1 Base end	●
80051	2 High vertical frames for CAPRI/ISCHIA/LINOSA	
80055	2 Reclining bag holders for CAPRI/ISCHIA/LINOSA	
80030	2 Nylon bags 150 lt with blue border for CAPRI/ISCHIA/LINOSA	
80045	6 Shelves for CAPRI/ISCHIA	●
GR80046	2 Drawers with lock for HOTEL	
80034	1 Nylon enclosing panel on 3 sides for ISCHIA	
GR80053/SET	1 Set of 6 long crossbars ISCHIA	
KITINNOVATIVE/I	1 Assembling kit for 80013	

From 15 to 18 rooms

 190/150x55x152hcm |  1 Pc/2 cartons 28 Kg 0,300 m³

 190/150x55x152hcm |  1 Pc/2 cartons 32,5 Kg 0,300 m³



Code	Description	Color
<b>80015</b>	<b>Hotel trolley ISCHIA 15</b>	
80025IDEA/BASE	1 Maxi base IDEA equipped with 2 castors with brake (item no. 80061) and 2 castors without brake (item no. 80060) Ø 125 mm	●
80043IDEA/BASE	2 Maxi base extensions with 1 castor Ø 125 mm without brake (item no. 80060)	●
80051	2 High vertical frames for CAPRI/ISCHIA/LINOSA	
80055	2 Reclining bag holders for CAPRI/ISCHIA/LINOSA	
80030	2 Nylon bags 150 lt with blue border for CAPRI/ISCHIA/LINOSA	
80045	6 Shelves for CAPRI/ISCHIA	●
GR80046	2 Drawers with lock for HOTEL	
GR80053/SET	1 Set of 6 long crossbars ISCHIA	
KITINNOVATIVE/J	1 Assembling kit for 80015	

From 15 to 18 rooms



Code	Description	Color
<b>80015/C</b>	<b>Hotel trolley ISCHIA 15C enclosed</b>	
80025IDEA/BASE	1 Maxi base IDEA equipped with 2 castors with brake (item no. 80061) and 2 castors without brake (item no. 80060) Ø 125 mm	●
80043IDEA/BASE	2 Maxi base extensions with 1 castor Ø 125 mm without brake (item no. 80060)	●
80051	2 High vertical frames for CAPRI/ISCHIA/LINOSA	
80055	2 Reclining bag holders for CAPRI/ISCHIA/LINOSA	
80030	2 Nylon bags 150 lt with blue border for CAPRI/ISCHIA/LINOSA	
80045	6 Shelves for CAPRI/ISCHIA	●
GR80046	2 Drawers with lock for HOTEL	
80034	1 Nylon enclosing panel on 3 sides for ISCHIA	
GR80053/SET	1 Set of 6 long crossbars ISCHIA	
KITINNOVATIVE/J	1 Assembling kit for 80015	

From 15 to 18 rooms

 190x55x152h cm |  1 Pc/2 cartons 32 Kg 0,300 m<sup>3</sup>

 190x55x152h cm |  1 Pc/2 cartons 36 Kg 0,300 m<sup>3</sup>



Code	Description	Color
------	-------------	-------

**80016 Laundry trolley LINOSA 1**

80025IDEA/LINOSA	1 Idea maxi base with 4 castors Ø 125 mm without brake (item no. 80060)	●
21003 B	2 Base ends	●
80048	2 Frames for LINOSA	
80035	1 Nylon bag 300 lt for LINOSA 1	
80053	2 Long bars for ISCHIA/LINOSA	
KITINNOVATIVE/K	1 Assembling kit for 80016	

Code	Description	Color
------	-------------	-------

**80018 Hotel trolley LINOSA 2**

80025IDEA/BASE	1 Maxi base IDEA equipped with 2 castors with brake (item no. 80061) and 2 castors without brake (item no. 80060) Ø 125 mm	●
21003 B	2 Base ends	●
80051	2 High vertical frames for CAPRI/ISCHIA/LINOSA	
80030	2 Nylon bags 150 lt with blue border for CAPRI/ISCHIA/LINOSA	
80053	2 Long bars for ISCHIA/LINOSA	
KITINNOVATIVE/L	1 Assembling kit for 80018	

 110x55x113h cm |  2 Pcs/cartons 28,5 Kg 0,290 m<sup>3</sup>

 110x55x152h cm |  1 Pc/carton 16 Kg 0,260 m<sup>3</sup>



Code	Description	Color
------	-------------	-------

**80019**

**Hotel trolley LINOSA 3**

80025IDEA/BASE	1 Maxi base IDEA equipped with 2 castors with brake (item no. 80061) and 2 castors without brake (item no. 80060) Ø 125 mm	●
21003 B	2 Base ends	●
80051	2 High vertical frames for CAPRI/ISCHIA/LINOSA	
80055	1 Reclining bag holder for CAPRI/ISCHIA/LINOSA	
80030	3 Nylon bags 150 lt with blue border for CAPRI/ISCHIA/LINOSA	
80053	2 Long bars for ISCHIA/LINOSA	
KITINNOVATIVE/M	1 Assembling kit for 80019	



Code	Description	Color
------	-------------	-------









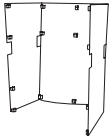
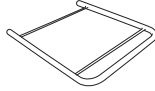

**80020**

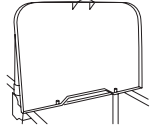
**Hotel trolley LINOSA 4**

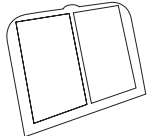
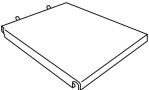

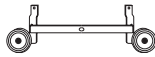
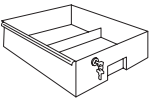
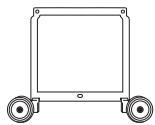

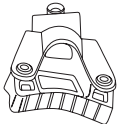

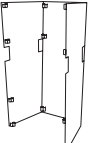
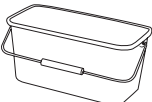
80025IDEA/BASE	1 Maxi base IDEA equipped with 2 castors with brake (item no. 80061) and 2 castors without brake (item no. 80060) Ø 125 mm	●
80043IDEA/BASE	1 Maxi base extension with 1 castor Ø 125 mm without brake (item no. 80060)	●
21003 B	1 Base end	●
80051	2 High vertical frames for CAPRI/ISCHIA/LINOSA	
80055	1 Reclining bag holder for CAPRI/ISCHIA/LINOSA	
GR80066	1 Bag holder with rubber ring for CAPRI/ISCHIA/LINOSA	
7031 BSV	1 Rectangular lid	●
80030	3 Nylon bags 150 lt with blue border for CAPRI/ISCHIA/LINOSA	
80053	2 Long bars for ISCHIA/LINOSA	
KITINNOVATIVE/N	1 Assembling kit for 80020	

140/110x55x152h cm | 1 Pc/2 cartons 18,5 Kg 0,260 m<sup>3</sup>

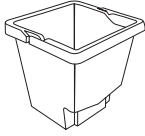
190/140x55x152h cm | 1 Pc/2 cartons 22 Kg 0,260 m<sup>3</sup>

Code	Description	Color	Code	Description	Color
 GR80066	Bag holder with rubber ring for CAPRI/ISCHIA/LINOSA		 80034	Nylon enclosing panel on 3 sides for ISCHIA	
 80055	Reclining bag holder for CAPRI/ISCHIA/LINOSA		 80038	Hood and closing front cover for CAPRI	
 7031 BSV	Rectangular lid	●	 80039	Hood and closing front cover for ISCHIA	
 7031AZR	Rectangular lid with transparent document holder	●	 80045	Shelf for CAPRI/ISCHIA	●
 1622	Rubber ring large		 80075	Multi-pocket panel for CAPRI/ISCHIA/LINOSA	
 80071	Bumper castors with frame for IDEA maxi base		 GR80046	Drawer with lock for HOTEL	
 80072	Bumper castors with frame for IDEA maxi extension		 80047/C	Pair of keys for CAPRI/ISCHIA	
 2255	Rubber handle holder with coupling system $\varnothing$ 22 mm		 2025 B	Tray small	●
 80032	Nylon enclosing panel on 3 sides for CAPRI		 2270 R	13 lt rect. bucket	●

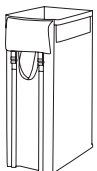

	Code	Description	Color		Code	Description	Color
	21005 B 21005 R	15 Lt bucket for IDEA	● ●		80035	Nylon bag 300 Lt for LINOSA 1	
	7030 B	22 Lt rect. bucket	●		80056	Nylon bag for 13 Lt bucket for CAPRI/ISCHIA	
	21065 KIT80040	Rilsan support for 22 Lt bucket for IDEABASE Fixing kit for rilsan vertical frame (1x80040, 2x2701/R, 2x2726, 2x2730)			80060	Castor Ø 125 mm without brake for maxi base with plate	
	7038	Lid for 22 Lt rect. bucket	●		80061	Castor Ø 125 mm with brake for maxi base with plate	
	7032	Folding stainless steel grid (for 22 Lt rect. bucket)			80062	Nylon castor for moquette Ø 125 mm without brake - plate coupling for IDEA maxi base	
	24053	Basket for IDEA	●		80065	Outdoor soft castor Ø 150 mm without brake for maxi base with plate	
	2723	Basket for bottles			KIT2701	Kit sets of aluminum plates for BIOSTEEL	
	80030 80030 G 80030 R 80030 V	Nylon bag 150 Lt with colored border for CAPRI/ISCHIA/LINOSA	● ● ● ●		1648	Plastic wing screw 6x15	
	80031	Open nylon bag for CAPRI/ISCHIA/LINOSA			21030 B	Plug for base	●

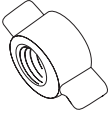
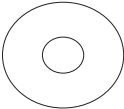
	Code	Description	Color
	21035 B	Threaded pin	●
	21036	Threaded ring nut	●
	4219	Washer 6x24	



Code	Description	Color
------	-------------	-------

**80022**

**Hotel trolley ELBA 1**

- GR2015 1 Chrome base 90x44 cm with 4 castors Ø 100 mm (item no. 2030) and bumpers
- GR1625 2 Vertical frames with bag holder and rubber ring
- 1610 1 Square lid
- 1680 1 Sanforized canvas bag 120 lt
- 2020 3 Shelves for small tray
- KITMULTIUSO/H 1 Assembling kit ELBA 1-2-3



Code	Description	Color
------	-------------	-------

**80023**

**Hotel trolley ELBA 2**

- GR2015 1 Chrome base 90x44 cm with 4 castors Ø 100 mm (item no. 2030) and bumpers
- GR1625 2 Vertical frame with bag holder and rubber ring
- 1610 1 Square lid
- 2225 1 Bag support
- 1680 1 Sanforized canvas bag 120 lt
- 2220 3 Shelves for large tray
- KITMULTIUSO/H 1 Assembling kit ELBA 1-2-3



 125x44x105h cm |  1 Pc/carton 17 Kg 0,150 m<sup>3</sup>

 140x44x105h cm |  1 Pc/carton 19 Kg 0,150 m<sup>3</sup>



Code	Description	Color
------	-------------	-------

<b>80024</b>	<b>Hotel trolley ELBA 3</b>	●
GR2415	1 Chrome base 100x44 with 4 castors Ø 100 mm (item no. 2030) and bumpers	
GR1625	1 Vertical frame with bag holder and rubber ring	
GR1625/TOP	1 Vertical frame without bag holder	
1610	1 Square lid	
2225	1 Bag support	
1680	1 Sanforized canvas bag 120 lt	
2020	3 Shelves for small tray	
KITMULTIUSO/H	1 Assembling kit ELBA 1-2-3	











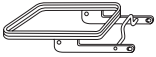

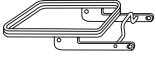
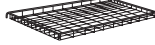
Code	Description	Color
------	-------------	-------

<b>80017</b>	<b>Hotel trolley ELBA 4</b>	
GR80017	1 X structure with 4 castors Ø 80 mm (item no. 1431) and bumpers	
1680/G	1 Sanforized canvas bag 230 lt	

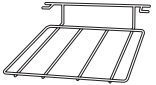
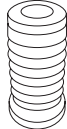
125x44x105hcm	1 Pc/carton	18 Kg	0,150 m <sup>3</sup>
---------------	-------------	-------	----------------------

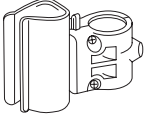
53x50x104h cm	2 Pcs/carton	17 Kg	0,175 m <sup>3</sup>
---------------	--------------	-------	----------------------

Code	Description	Color	Code	Description	Color
	1620	Bag holder without rubber		2020	Shelf for small tray
	GR1620	Bag holder with rubber ring		2220	Shelf for large tray
	1622	Rubber ring large		1431	Castor Ø 80 mm with plug and thread guard
	1610	Square lid		2030	Castor Ø 100 mm with thread 8x28 and thread guard
	2225	Bag support		1432	Bush for castor with plug (item no. 1431)
	1625	Vertical frame		1031	Small bumpers
	KIT2230	Kit handle holder Ø 22 mm with coupling system			
	1680	Sanforized canvas bag 120 lt			
	1680/G	Sanforized canvas bag 230 lt			











# Sale conditions

---

## ORDERS

- Each order implies the purchaser's acceptance of our sales conditions.
- Each order is considered as accepted and confirmed "after approval of our sales department". Any cancellation can be accepted only within 24 hours from the receipt of the order.
- All items are packed according to the quantities stated in our price-list.
- In case the ordered quantities do not correspond to our standard packaging, they will be automatically rounded up.

## CURRENCY AND PRICES

- All listed unit prices are expressed in Euro. They are excluding VAT and are valid until further notice. The new prices will be communicated with one month prior notice.

## DELIVERY TERMS

- The agreed delivery terms have to be considered as binding. Any possible delay caused by circumstances out of our control cannot cause any order cancellation nor any penalty.
- It is the purchaser's duty to check carefully the goods upon delivery and notify any damage or lack directly to the driver/forwarder, making a written reserve on the delivery note.

## SPECIAL VERSIONS

- For prices of customized trolleys please contact our Commercial Department.

## RETURNS

- In principle, the return or the substitution of goods delivered in accordance with the confirmed order, will not be accepted. Any return must be authorized by our Company. In case of approved return, goods must be shipped on free delivered basis, in perfect conditions and packed in the original carton boxes. The credit note will be issued taking into consideration possible value decrease.

## PICTURES AND DRAWINGS

- Pictures and drawings shown in this price-list are sole property of VDM Srl. Their use in any form without written permission of VDM Srl is therefore forbidden. Even in case the diffusion of pictures of our products is authorized, it is requested to indicate expressly that these are VDM Srl products. The descriptions and drawings are provided merely for information purposes. VDM Srl reserves the right to make any modifications considered necessary or useful, even without prior notice.

## RETENTION OF TITLE

- All delivered goods remain property of VDM Srl company until the purchaser has totally settled their payment. The purchaser is allowed to sell them, provided that he is aware that they are subject to a clause of retention and that the first seller can claim their payment or property, in case the relevant amount hasn't been settled on the expiring date

## JURISDICTION

- The court of Milan will have exclusive jurisdiction on any dispute related to the above mentioned terms and conditions.





Distributor:



**VDM S.r.l.** Viale delle Industrie 16/8 - 20020 Arese (MI) - ITALY

[www.vdm.it](http://www.vdm.it)